

Grant agreement no.: FCH-JU-325386



Support to Safety Analysis of Hydrogen and Fuel Cell Technologies

Model Validation Database



The SUSANA project is co-funded by the European Commission within the 7th Framework Program

Authors

(randomly ordered by list of partner Institutions)

Olaf Jedicke (project coordinator)

Ke Ren

Alexei Kotchourko

Volodymyr Shentsov

Dmitriy Makarov

James Keenan

Vladimir Molkov

Daniele Baraldi

Ilias Tolia

Stella Giannisi

Alexandros Venetsanos

Simon Coldrick

Shane Slater

Frank Verbecke

Audrey Duclos

Copyright

This Document has been created within the FP7 project SUSANA. The utilization and release of this document is subject to the conditions of the contract within the 7th EU Framework Program. Project reference is Grant agreement no.: FCH-JU-325386

Content

VALIDATION DATABASE	4
1.1 INTRODUCTION	4
WEBSITE OF VALIDATION DATABASE	5
1.2 PHYSICAL PHENOMENA IN DATABASE	5
1.3 TOPICS OF EXPERIMENTS.....	7
1.3.1 <i>Summary:</i>	8
1.3.2 <i>Author:</i>	8
1.3.3 <i>Experimental setup:</i>	9
1.3.4 <i>Objective of the experiment:</i>	10
1.3.5 <i>Applicable calculations:</i>	10
1.3.6 <i>Experimental procedure:</i>	10
1.3.7 <i>Experiment data:</i>	11
1.3.8 <i>Performed simulation:</i>	11
1.3.9 <i>References:</i>	12
1.3.10 <i>Comments:</i>	12
EXPERIMENTS IN VALIDATION DATABASE.....	13
QUALITY ASSURANCE.....	21
ACKNOWLEDGE.....	23
APPENDIX I.....	24
APPENDIX II.....	38

Validation Database

1.1 Introduction

According to the task 5.1 of project SUSANA, validation database should be built. The subtask will review the experiments available and suitable for inclusion into Model Validation Database and intended benchmarking.

The experiments will be arranged by phenomena and distributed inside a further subdivision with the aim of the creation of a detailed database. The database will include a general description of the experiment, the references to original sources and digitalized experimental records. At the very beginning of the project, website of validation database has been created. Currently, more than 90 experiments are available on the website. Details of the experiment format will be introduced in Chapter 2 and Appendix I. Experiments available in the database are shown in Chapter 3 and Appendix II.

Meantime, in order to make sure that all the experiments on website are in high quality, proper evaluation method of the experiments is introduced to the validation database. On Chapter 4 the quality assurance are introduced in detail.

Remark:

Before the introduction of setting and contents of validation database, it is necessary to reaffirm the differences between verification and validation, verification database and validation database. Then the users may have a clearer idea about the usage of validation database.

Verification is the process of determining that a model implementation accurately represents the developer's conceptual description of the model and the solution to the model. The goal is to ensure as far as possible that the equations are being solved correctly. The objective of verification is to identify and minimize errors in coding (coding errors, incorrect material properties or boundary conditions) as well as numerical errors (from sources such as temporal or spatial discretization).

The verification database provides a number of practical worked verification examples all related to hydrogen simulation. It demonstrates procedures, techniques and worked examples to inform and help practitioners in the hydrogen safety CFD area to determine the fidelity of modelling and simulation processes. To aid the identification of useful references the verification database entries are grouped according to the primary verification process they refer to. These are: Analytical solutions; Code verification; Manufactured solutions; Methodology; Numerical solutions; Sensitivity studies (grid and parameter sensitivity). The database can be found at: (<http://www.support-cfd.eu/index.php/verification-database>).

Validation is the process of determining the degree to which a model is an accurate representation of the real world from the perspective of the intended uses of the model. The goal is to ensure as far as possible that the correct equations are being used.

The model validation database aims to support successful code validation applied to hydrogen safety analysis. The database contains high quality experiments and covers a range of physical phenomena. It contains a full description of each experiment including the experimental setup and the obtained experimental results, which are publicly available via the SUSANA project website (<http://www.support-cfd.eu/mvdb/>). Validation should be performed using several experiments which determine the model's range of applicability.

Website of Validation Database

Building the website for database is the fundamental part of the validation database, both experiment updating and quality assurance rely on the website. On September 2013 the design of the website begun and on November basic items of the website were established. The validation Database is located at the web support-cfd.eu.

1.2 Physical Phenomena in Database

On website, in order to assist users of the database finding the proper experiments quickly, all the experiments are classified into 5 main physical categories: Release & Distribution, Ignition & Fire, Deflagration, Deflagration to Detonation transition (DDT) and Detonation. Detailed descriptions of the physical categories are given in following table 2.1.

Table 2.1 Physical Categories in Database

Physical Categories	Description
Release & Distribution	Investigation of the flow motion and distribution of hydrogen (Helium) gas after injected from high pressure vessel with supersonic or sub-sonic speed. Meantime, distribution of hydrogen gas from liquid hydrogen source is included in this category.
Ignition & Fire	Self-ignition or ignition of released hydrogen gas.
Deflagration	Subsonic speed flame in confined vessel or open environment.
DDT	Flame acceleration of the flame from subsonic flame to supersonic flame.
Detonation	Directly initiated supersonic flame in confined vessel or open atmosphere.

Figure 2.1 shown below is the interface of Database, 5 main physical categories are listed in the lower part of the web. For convenience, the user can click the button 'physical category' in the upper part of the website and only the experiments belonging to the corresponding category will be displayed in the lower part. Additionally, users can also use the button 'CSV' or 'PDF' to download the experiment.

Model Validation Database

The interface includes a top navigation bar with buttons for '+ Add', 'Group by', 'CSV', 'PDF', and 'Empty'. Below this is a search section with a 'Search:' label, a 'Clear filters' button, and a 'Category' dropdown menu currently set to 'All'. The main content area displays a table with columns: 'id', 'Experiment Type', 'Experiment Name', 'Short description', 'Approval', and 'Description'. The table lists five categories with expandable arrows and counts: 'Deflagration of hydrogen gas (21)', 'Deflagration to detonation transition (DDT) (7)', 'Detonation of hydrogen gas (3)', 'Release & Distribution of hydrogen gas (27)', and 'Ignition & Fire of hydrogen gas (34)'. At the bottom left, there is a 'Display #' dropdown menu set to '10'.

Figure 2.1 Interface of Database

Inside each category, experiments are displayed in the order of input. On the list of the experiments, important information such as the name of experiment, short description of experiment, the approval of the experiment and the data provided by the experiment are provided. Short description of the experiments includes the basic information such as the size of experimental facility, concentrations of gas species and the phenomenon in the experiments, with the help of the descriptions the users can get understand if the experiment can be used for the code validation. Description of the experimental data shows what specific data is provided by the experiment, for the users who have special requirements to the experimental data in validation the data description may bring them some conveniences. In all, through the information provided on the list, users of the database can get basic knowledge of each experiment and make selection quickly.

Category Deflagration of hydr ▼

id	Experiment Type	Experiment Name	Short description	Approval	Description	<input type="checkbox"/>	✕
▼ Deflagration of hydrogen gas (14)							
5	Deflagration		The experiment was performed in the HYKA A2 experimental facility. A homogeneous mixture of hydrogen (10 vol.%), steam (25 vol.%) and air was established in the vessel. The initial pressure was 1.49 bar, and the average initial temperature was about 90.0 °C. The mixture was ignited at the bottom of the vessel and the ensuing axial and radial flame propagation were observed. Pressure and temperature were measured at different axial and radial locations.	yes	The pressure data and temperature data from the transducers.	<input type="checkbox"/>	✎ 🔍 ✕
6	Deflagration	HYCOM-HYC 14	Combustion experiments have been carried out in large scale multi-compartment geometry	yes	All pressure recordings in digital form	<input type="checkbox"/>	✎ 🔍 ✕

1.3 Topics of Experiments

In the website, in order to provide the information of each experiment systematically and completely, all the information about the experiment are given in 10 topics. The 10 topics include all aspects of the experiment and can help the users having a detailed understanding of the experiments. The 10 topics include:

- **Summary** Short description of the experiment, including the draft drawing, simple description and keywords.
- **Author** Who did the experiment and who are responsible to the experiment.
- **Experimental Setup** Detailed description of the experimental facility, boundary setting and location of instrumentations.
- **Objective of Experiment** Which physical phenomena are investigated in this experiment.
- **Application Calculation** Which kinds of numerical model can be validated by this

- experiment.
- **Experimental Procedure** Detailed description of experimental phenomena, including the figures or movies.
 - **Experiment Data** Results of the experiment, including some explanations for the experiment data.
 - **Performed Simulation** Some validation cases by using the experiment.
 - **Reference** Publications related to the experiments.
 - **Comments** Some suggestion from the user, the interface for the communication between the users and publishers of the experiment.

In each topic of the experiment several sub-topics are shown to the users, therefore all information can be provided systematically and clearly to the users. In the following parts, descriptions of the sub-topics of each topic are shown in detail (more detailed illustrations are provided in Appendix I).

1.3.1 Summary:

The topic summary is the short description of the experiment. Users can get basic information of the experiment in this topic. Subtopics and their descriptions are shown in the Table 2.2.

Table 2.2 Sub-topics in Summary

Category	The physical phenomena category of the experiment.
Experiment Type	The main physical phenomena studied by the experiment.
Experiment Name	The name or ID of the experiment.
Keywords	The keywords of the experiment
Draft drawing or simple description for the facility	The simplified drawing or written description for the experiment facility.
Short Description	Few words about the experiment background, purpose and preparation.

1.3.2 Author:

The topic is the full information of the experiment participants and the contact information of the experiment publisher. Such topic is necessary for the maintenance and quality assurance of the experiment. Details of the sub-topics are shown in Table 2.3.

Table 2.3 Sub-topics in Author

The main participants	The experts who made the experiment. If necessary, the links to personal website of those experts can be provided by SUSANA web.
The experiment time	Start and end dates of the experiment.
The relevant agencies	The agencies (universities, research institutes and companies) attended in the experiment. If necessary, the links to the official websites of those agencies can be provided.
The place of the experiment	The location (the country, state, institute) of the experiment.
The data provider	The person provided the experiment to SUSANA website.

1.3.3 Experimental setup:

This sub-topic is the detailed description for the experiment facility and instrumentation. This is the key part for the construction of computational domain. Sub-topics are shown in Table 2.4.

Table 2.4 Sub-topics in experimental setup

Components	The main components of the experimental facilities. Some experimental facilities may have several components, number and size of the components should be given in this part.
Boundary geometry	Geometrical information for special boundary such as the fan, the release source and ignition point. <ul style="list-style-type: none"> - The type of the boundary (source, velocity, pressure) - The size of such special boundary (can be given in the latter facility drawing) - The location of the special boundary (can be given in the latter facility drawing)
Instrumentations	The instrumentations used in this experiment, detailed information should cover: <ul style="list-style-type: none"> - The types of the instrumentations - The numbers of the instrumentations - The position of the instrumentations (can be given in the latter facility drawing)
The mutable variables in the facility	Sometimes, geometry may also be a mutable factor in experiment, including <ul style="list-style-type: none"> - The destructible boundary and parameter of the boundary - The mutable geometry in the facility (such as the size of the obstacles is mutable when the influences of the different geometry is studied by the experiment)
Drawing or detailed written	The detailed description of the experiment facility. All

description of facility	information mentioned above should be included in the drawing.
-------------------------	--

1.3.4 Objective of the experiment:

In this topic, the purposes of the experiment are given. Sub-topics are shown in Table 2.5.

Table 2.5 Sub-topics in objective of the experiment

Experimental goals	What detailed physical phenomena are planned to be studied by the experiment originally.
Phenomena	What physical phenomena can be studied from the experiment results.

1.3.5 Applicable calculations:

This topic shows the users what numerical or physical models can be validated by the experiment. Such topic can improve the validation efficiency and help the users making their own judgment about if the experiment is proper for their code. Subtopics are shown in Table 2.6.

Table 2.6 Sub-topics in applicable calculations

Fluid governing equations	The transportation equations used to describe the gas dynamics.
Chemical models	The models used to simulation the chemical reaction.
Boundaries	Numerical method used to simulate the boundary.

1.3.6 Experimental procedure:

This topic shows the experimental process, including preparation and detailed experimental phenomena. This topic contains the key parameters of the experiment, setting of initial conditions and boundary conditions rely on this topic. Sub-topics are shown in Table 2.7.

Table 2.7 Sub-topics in experimental procedure

Initial condition	The initial state inside the experiment facility, including <ul style="list-style-type: none"> - Gas species and their ratio - Initial pressure - Initial temperature - Initial velocity - Turbulence parameters
Boundary condition	Some experiments have special boundary conditions such as the source of the gas, velocity inlet or outlet and pressure boundary.

Descriptions	Some written description for the experiment, including <ul style="list-style-type: none"> - Preparation of the experiment - Experiment procedure - Experiment phenomena - Theoretical analysis - Conclusions
--------------	---

1.3.7 Experiment data:

Final experiment results are given in this topic. Sub-topics are shown in Table 2.8.

Table 2.8 Sub-topics in experiment data

Availability	If the data can be accessed by the public.
Description	Some information about the experiment data, including <ul style="list-style-type: none"> - Measurement procedures - Measured quantities - Measure errors - The format of the data file - Description for each data file
Experiment data	The final result, experiment data collected under different conditions can be shown in different sub-topics.
Figure	Time dependent figure of the quantities measured by the instrumentations. Figures should be classified by the instrumentation types or physical quantities, and each figure should be marked by the position.
Video	Videos can express the experiment phenomena objectively. <ul style="list-style-type: none"> - Overview of the experiment facility - Preparation of the experiment - Detailed experiment phenomena

1.3.8 Performed simulation:

In this topic, some code validation examples based on the experiment are shown. For each example, the sub-topics should be as shown in Table 2.9.

Table 2.9 Sub-topics in each example

Author	The people or agencies attended in the validation.
Validation code	The code validated or verified by the experiment.
Mathematical treatments	The mathematical methods used to make the data processing.
Setting of domain	The setting of the computational domain in this calculation,

	<p>including</p> <ul style="list-style-type: none"> - Grid structure and resolution - Construction of the geometry - Initial condition - Establishment of the boundary conditions - Properties of the physical boundary - Figures of the domain
Validation Models	The numerical models validated or verified by the experiment data.
Validation results	<p>The validation results, including:</p> <ul style="list-style-type: none"> - Figures - Conclusion

1.3.9 References:

In this topic, papers related to this experiment are given. Sub-topics are shown in Table 2.10.

Table 2.10 Sub-topics in references

References about the experiment from the participants	<p>The reports and papers published by the experiment participants, including:</p> <ul style="list-style-type: none"> - Reports or papers about the experiment - Analysis for the experiment - Validation made by the experiment participants
References about the experiment from the third party	<p>The reports and papers published by third party related to the experiment, including:</p> <ul style="list-style-type: none"> - Reports or papers about the repeatability of the experiment - Analysis for the experiment - Validation made by the third party

1.3.10 Comments:

Inside the topic some comments from the users are listed, the comments can be displayed by time. Additionally, if the questions in the comment part are answered by the publisher or administrator the answers will be displayed after the question.

Experiments in Validation Database

Currently, more than 90 experiments have been uploaded to the validation database. Following Table 3.1 shows short descriptions of all the experiments available in the database (to save pages, the experiments who share the same experiment facility are mentioned as one in the Table, but in the website the experiments are uploaded separately). More detailed illustrations of each experiment are provided in the Appendix II.

Table 3.1 Experiments in Validation Database

Category		
Release & Distribution	Gamelan_60NL_A, Gamelan_60NL_B, Gamelan_60NL_C,	Helium released from the nozzle which was installed inside the 1 m ³ vented box. Release rate of the gas is 60NL/min and three different types of venting A, B and C are used in three experiments. Volume fraction of Helium is measured at different positions inside the box.
	Gamelan_300NL_A	Helium released from the nozzle which was installed inside the 1 m ³ vented box. Release rate is set as 300NL/min and the venting type is A. Volume fraction of Helium is measured at different positions inside the box.
	Gamelan_180NL_B	Helium released from the nozzle which was installed inside the 1 m ³ vented box. Release rate is set as 180NL/min and the venting type is B. Volume fraction of Helium is measured at different positions inside the box.
	HYSAFE_SBEP_V21	Helium was released continuously from the nozzle set inside the garage side vented facility. Volume fractions of the gas are measured at different positions.
	GEXCON_06, GEXCON_27, GEXCON_58	Hydrogen gas was released as a jet inside lab scale facility. Three different obstacle setting accompany with different nozzle diameter are used in experiments to investigate the behavior of hydrogen.
	INERIS-6C	Hydrogen was released inside a vented facility with the volume of 70 m ³ . Volume fractions of the hydrogen are measured at

		different position.
	NASA-6	Liquid hydrogen are disposed in open environment with constant wind flow, volume fractions of hydrogen are measured by sensors located at downwind position.
	SBEP_1	A subsonic release of hydrogen in a closed vessel with the volume of 20 m ³ . Volume fractions of the gas are measured at 6 sensors inside this vessel.
	SWAIN_GARAGE	Helium was released in a vented garage which has a 1:1 car model inside. Volume fractions of the Helium are measured at different positions.
	SWAIN_HALLWAY	Helium was released in vented tunnel model. Volume fractions of the gas are measured at different positions.
	Release 1	Hydrogen distribution tests in horizontal free turbulent jet have been carried out in a compartment with an internal volume of 160 m ³ . Experimental facility consisted of high pressure gas system to provide hydrogen release at pressures in the range 20 – 260 bar through the nozzle.
	HSL-Test 5, HSL-Test 6, HSL-Test 7	LH2 (liquid hydrogen) is released horizontally along ground through an orifice with different setting. The ground is concrete. Distribution of hydrogen under different release setting is investigated.
	KIT HIWP4-001, KIT HIWP4-002, KIT HIWP4-003, KIT HIWP4-004, KIT HIWP4-005, KIT HIWP4-006, KIT HIWP4-040,	The Test-Chamber has the dimensions 5.5x8.5x3.4 m ³ with a volume of approx. 160 m ³ . Different settings of releases were installed inside the experimental facility. The series of experiments are aim to investigate the distribution of light gas in the closure environment.
Ignition	PRD	High pressure hydrogen gas was released

		through the pressure relief devices. Relation between the gas pressure and self ignition is investigated.
	Indoor jet fire WP4/1-8, Indoor jet fire WP4/9-12,	A carbon steel enclosure with volume 31 m ³ and five passive vents located on the side walls is used as experimental facility. The vents could be fully or partially closed using steel plates and gaskets, or left open to the atmosphere in different experiments. In the middle the release orifice with different diameters are used. In the series of experiments, the jet fires under different setting of release orifices and venting are investigated.
	KIT HIWP4 07-21, KIT HIWP4 35-37, KIT HIWP4 57-59, KIT HIWP4 62	Inside the industrial scaling facility (about 160 cubic meters in volume), the phenomenon of jet fire with different orifice size, flow rate and venting are investigated.
Deflagration	Blast Wave	The cylinder was filled at 34.5-MPa (1.64 kg) of hydrogen, 84 cm long, 41 cm diameter, with an inner volume of 72.4 L. The cylinder was placed over a propane bonfire source of 370 kW exposure. The cylinder was exposed to the fire for 6 min 27 sec when it lost its integrity and failed catastrophically.
	HYCOM-HYC01	10% Hydrogen-Air mixture in RUT facility was ignited at the end of round tunnel. Pressure data was collected in the experiment.
	HYCOM-HYC14	11.5% Hydrogen-Air mixture in RUT facility was ignited at the corner of canyon. Pressure data was collected in the experiment.
	HYCOM-MC03	In the 12.2 m long 174mm diameter tube, repeated obstacles with block ratio 0.6 are installed. 10% Hydrogen-Air mixture was filled in this tube and ignited at one end of the tube.

	HYCOM-MC12	In the 12.2 m long 174mm diameter tube, repeated obstacles with block ratio 0.6 are installed. 13% Hydrogen-Air mixture was filled in this tube and ignited at one end of the tube.
	HYCOM-MC43	One 12.2 long 174mm diameter tube was separated by membrane in the middle. Two parts are filled with different Hydrogen-Air mixtures and installed with repeated obstacles with different block ratio. Ignition was made at one end of the tube and then the flame propagation was investigated.
	HYCOM-HC20	10% Hydrogen-Air mixture was fill in the facility combined by two tubes with different diameters. In the two tubes repeated obstacles with different block ratios were installed. Ignition was made at the end of large diameter tube, and the propagation of flame was investigated.
	Kumar1983	Large sphere structure vessel was filled with 29.5% Hydrogen-Air mixture, ignition was given at the center of the vessel and the pressure data was collected through the sensors installed at on the wall.
	HylnDoor_WP3	Vented 1 m ³ box was filled with 18% Hydrogen-Air mixture initially. Then the ignition was given at the center of the wall opposite to the vent. Pressures along the vented fire were measured.
	Open Deflagration	20m diameter hemisphere balloon was filled with 29.5% Hydrogen-Air mixture, ignition was given at the center of the balloon and the pressures were measured.
	Vented_Def_BI_27V, Vented_Def_BI_54V, Vented_Def_CI_27V, Vented_Def_CI_54V, Vented_Def_FI_27V, Vented_Def_FI_54V	In a large vented vessel, 10% Hydrogen-Air mixture was filled inside. Different ignition locations and venting size were used at different experiments. Relation between combustion and experiment setting are investigated.
	MINIRUT_m40	Deflagration is made in the experimental facility with complex geometrical structures.

		In the experiment the behavior of flame in complex obstructed environment is investigated.
DDT	DDT_RUT	In RUT facility, different Hydrogen-Steam-Air mixtures were ignited to investigate the flame acceleration and DDT. Pressure data were collected by sensors located in the facility.
	FZK-R 049809	15% Hydrogen-Air was filled in the 12m long 350mm diameter tube. In order to boost the mixing effect, 0.3 block ratio repeated obstacles were installed in the tube. Lighting sensors and pressure sensors are installed in the tube to collect experiment data.
	DDT_MINIRUT_m46	Different Hydrogen-Air mixtures in the small scale 'RUT' facility were ignited to investigate the DDT behavior. Pressure data and light signal were collected in the experiment. Differently from the case m40, the obstructed channel was prolonged by 20 cm obstructed sub-channel to boost flame acceleration.
	DDT_MINIRUT_m44	Different Hydrogen-Air mixtures in the small scale 'RUT' facility were ignited to investigate the DDT behavior. Pressure data and light signal were collected in the experiment. Differently from the case m40, the obstructed channel was prolonged by 60 cm 'smooth' sub-channel to boost flame acceleration.
	GRS029, GRS037	Inside the closure vessel A2 in KIT, and partial confined obstructed channel was filled with homogenous hydrogen-air mixture, the DDT process in such environment is investigated. In the two experiments, different hydrogen concentration and channel heights are used.
GRS056, GRS057	Inside the closure vessel A2 in KIT, and partial confined obstructed channel was filled with hydrogen-air mixture which has gradient in vertical direction, the DDT	

		process in such environment is investigated. In the two experiments, different hydrogen concentration gradients are used.
Detonation	KI_RUT_hyd09	RUT facility was filled with 25.5% Hydrogen-Air mixture, initiation of the detonation wave was accomplished by the 100g TNT located at the end of round tunnel. Pressure data was collected by the pressure sensors.
	KI_RUT_hyd05	RUT facility was filled with 20% Hydrogen-Air mixture, initiation of the detonation wave was accomplished by the 100g TNT located at the corner of canyon. Pressure data was collected by the pressure sensors.
	Open_detonation	Similarly to the setting of Open deflagration, hemisphere balloon was filled with 29.5% Hydrogen-Air mixture. Detonation was imitated directly in the center of the balloon.

In the establishment of the validation database, numbers of experiment is one of the most important considerations. Usually the code validation requires the calculation of large amount of experiments containing the same or similar physical phenomenon to show its' capability in solving certain physical problems. However, for code validation, the redundancy of the experiments is not the only requirement. For a comprehensive code validation, the experiments used should cover different characteristics such as scaling, geometrical complexity and confinements.

Firstly, scaling of the experiments is a quite important consideration in selecting experiments. Table 3.2 shows the numbers of experiments in different scaling in each physical category. In the table, experiments are classified into 3 categories: laboratory scale, the medium scale and industrial scale.

Table 3.2 Scaling of experiments

Category	Laboratory Scale (<1 cubic meter)	Medium Scale (~10 cubic meter)	Industrial Scale (>100 cubic meter)
Release & Distribution	7	8	12
Ignition & Fire	1	11	22
Deflagration	6	8	5
DDT	2	5	2
Detonation	0	0	3

In experiments of hydrogen behaviours, investigation of influence of scaling of the facility is a very important aspect. For code validation, it is also necessary to use experiments under different scaling to show the numerical code have the capability in reproducing phenomenon in different scaling. Shown in table 3.2, in category Release & Distribution, Deflagration and DDT, the numbers of experiments in three different scaling achieve good balancing; in the category Ignition & Fire the experiments focus more on medium and industrial; in the category the 3 experiments focus only on the industrial scaling. It is worth to note that for Ignition and Fire, especially for the experiments focused on fire, to avoid the influence of wall and open boundaries most of the experiments are given inside big volume experimental facility which are in the magnitude $10\text{ m}^3 \sim 100\text{ m}^3$. Detonation is usually concerned more in industrial safety issues, so experiments in this category focuses on industrial scaling. Therefore, under the consideration of experimental requirements and users' requirements, balancing in scaling is achieved in each category.

Then, in the selection of experiments, complicated geometry is another important factor concerned. In industrial problems, pipes, equipment and walls are quiet common and can perform as complicated geometrical structures in numerical simulations, the numerical codes for industry must have the capability in solving problems containing complicated geometry. To support the validation of code for industry, experiments containing complicated geometrical structures are necessary. In current status, experiments in validation database focus more on the problems with complicated geometry, but to the phenomenon in simple geometrical environments enough attention has been paid as well. Table 3.3 shows the numbers of experiments containing complicated geometry and experiments containing simple geometry in each category. Shown by the table, current validation database has paid enough attention to the problems with complicated geometry.

Table 3.3 Scaling of experiments

Category	Simple Geometry	Complicated Geometry
Release & Distribution	12	15
Ignition & Fire	11	23
Deflagration	6	13
DDT	5	4
Detonation	1	2

The last but not the least, in selection of experiments, the confinement of experimental facility is considered. Lots of experiments have proved that confinement of the facility sometimes can dominate the results of the experiments, for code validation such important determining factor should be considered. So, in each physical category at least two different confinement levels are focused. In Table 3.4, the status of confinement in each physical category are shown, and it can be found that except DDT which is quite rare in open atmosphere and detonation in which only three experiments are provided the other categories have experiments in 3 different confinement categories.

Table 3.4 Confinement of experiments

Category	Fully Confined	Partial Confined	Open
Release & Distribution	9	12	7
Ignition & Fire	23	10	1
Deflagration	10	7	2
DDT	5	4	0
Detonation	2	0	1

Totally speaking, in the establishment of validation database not only the amount of experiments is considered, but also the balancing in other aspects such as scaling, geometrical complexity and confinement are considered. Experiments in current validation database are adequate for comprehensive validation of numerical codes.

Quality assurance

Both quantity and quality are important to a successful database. Big number of experiments can satisfy the requirements from different users and provide more confidence to the code. Meantime, quality of the experiments is also important, validation through high quality experiments can provide more confidence to the code.

To reach a high quality, each experiment in SUSANA validation database should pass through the so called publisher-reviewer cycle. Figure 4.1 shows the publisher-reviewer cycle. It is clear that main components of this cycle are publishers, reviewers and administrators. Publishers are the people who are responsible for uploading experiment to database. Reviewers are invited experts or experienced CFD developers/users of SUSANA project participants who can evaluate the quality of experiment. Administrators are ones who take in charge of the maintenance and management of the website.

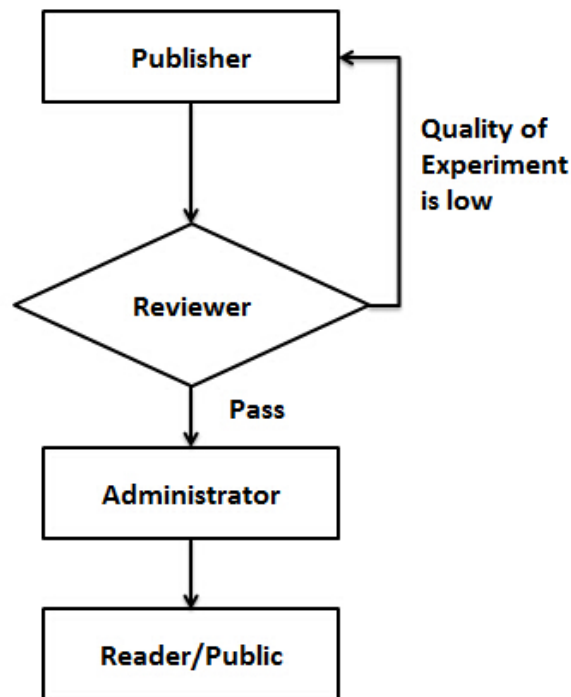

Figure 4.1 Quality assurance

In the cycle, firstly the experiments should be uploaded to the website by the publishers. At this moment, the experiments been uploaded are marked as no in the approval part, which means that the experiments are only available to the publishers, reviewers and administrators but not to the reader/public. Then, at least two reviewers will be notified by the auto-email or publishers to evaluate the quality of the experiment. In the evaluation phase the reviewers will evaluate if the experiment can be used for validation (by judging if enough information about the geometry, initial condition and boundary condition are provided) and the quality of the experiment (through the description of the experimental procedure, movie, experiment results and the capability of the experiment agency). After the evaluation, high quality experiment will be marked as yes in the

approval part and open to the readers/public through the operation of administrators, but low quality experiment will be sent back to the publishers for further optimization. So, with the help of publisher-reviewer cycle, all the experiments shown to the readers/public are guaranteed in its quality. Currently, 8 publishers and 11 reviewers are working for the validation database. Details of the publishers are shown in Table 4.1.

Table 4.1 Publishers and reviewers in each partner

Partner	Publishers	Reviewers
KIT	2	2
UU	2	2
NCSR	2	2
JRC		1
HSL		1
EE	1	1
AREVA	1	2

In addition, after the experiment is open to the readers/public, evaluation of the experiment and the improvement of the quality are still possible. The comment part and the author part of each experiment provide a perfect feedback interface between the publisher and readers. Firstly, readers can contact the publishers through the contact information provided by the author part to ask question and give comments. In this way, errors can be found quickly and improvement can be made immediately. If due to some technique reasons (such as the departure of the publishers or problems of the email), reader can use the comment to leave message to the administrators and the administrators can contact the publisher who is responsible to the experiment or the other publishers who also have enough knowledge to the experiment to fix the problem.

The last but not the least, the setting of the database make it is possible to increase the quality of each experiment. Compared to the common quality assurance through 'fixing' problems, increasing the quality of the experiment is more positive quality assurance. In the performed simulation part, some validation works based on the experiment can be displayed directly. In the reference part, publication of numerical work based on the experiment is included. Those validation examples and references can show the compatibility of the numerical simulation to the real experiment, good compatibility not only shows that the numerical model can reproduce the real world but also shows that the experiment itself fits the theory. As more and more validation examples or publications are included in the performance simulations or reference parts, quality of the experiment will increase and more users will use the experiment to make code validation, such feedback mechanism can improve the quality of experiment in a long period of time.

Acknowledge

Delivery D5.1 uploaded on April of 2015 is a midterm report of the status of validation database, in the report structures of validation database, template of experiments and the quality managements are introduced in detail. Since the D5.1, all partners of the project SUSANA focus on uploading high quality experiments to validation database, but little modification has been made to the structures of validation. Delivery D5.4 is the final report of the task 5.1, to maintain consistency and integrity, the D5.4 is made based on the Delivery D5.1.

In Chapter 3, since more experiments are uploaded to the database, names and short descriptions of the new experiments are added to the table of experiments. At the end of the Chapter3, different from the D5.1 in which the balancing of scaling in the whole validation database is investigated, D5.4 investigates the balancing of scaling, geometrical complexity and confinement in each physical category. More systematic analysis of the experiments in validation database is given in D5.4 to show the database can support comprehensive validation work for hydrogen safety CFD codes.

In Chapter 4, in quality promoting part the reference uploaded by the users has been added. Not only the detailed description of numerical work in performed simulation can promote the quality of experiments, the reference of published numerical works based on the experiment can have the same efforts.

In Appendix II, since more experiments are available in database, summaries of the new experiments are added to this part.

Appendix I

In Chapter 2, topics and sub-topics of each experiment in database are shown. However, limited by the pages the detailed illustration of the topics cannot be provided in the Chapter. Therefore, detailed descriptions are shown in Appendix I.

Summary:

The topic summary is the short description of the experiment. Users can get basic information of the experiment in this topic.

<p>*Experiment Type</p>	<p>The main physical phenomena studied by the experiment.</p> <p>For example: Deflagration</p> <p>Words appeared in this sub-topic should be from the terminology list of SUSANA, the terminology list will be built later.</p> <p>Experiment type dominates the final classification of the experiment in the SUSANA website, and can bring lots of convenience when distributing this article to the reviewers.</p> <p>Such item is decided by the publisher, so it is better to provide this information in the article submitting.</p>
<p>*Experiment Name</p>	<p>For naming the experiment.</p>
<p>*Keywords</p>	<p>The keywords of the experiment</p> <p>The keywords are used for the search function in the website. For each article, 4-5 keywords should be given. For example: the wrinkled fire, premixed mixture, closed environment and etc. Those key words should also be from the terminology list of SUSANA.</p> <p>The keywords are decided by the publisher, it is better to provide those words in the submitting phase.</p>
<p>Draft drawing or simple description for the facility</p>	<p>The simplified drawing or written description for the experiment facility.</p> <p>For the users, establishing the computational domain is very important task. The draft drawing of the experiment facility can help them judging if their code can deal with the geometry in this experiment.</p> <p>Information in this topic just provides a more comprehensive view of the experiment. Indeed, this topic can be kept in blank in article submitting phase.</p>

*Short description	<p>Few words about the experiment background, purpose and preparation.</p> <p>The short description provide the basic information of the experiment, users can make preliminary assessment on if the experiment is proper for the Validation (if their code has the capability to make the simulation).</p> <p>Normally, report of the experiment has some brief description for the experiment. If no description is available, the publishers can make it by themselves.</p>
--------------------	--

When clicking inside one experiment data, the summary of the experiment should be given firstly. Summary of one experiment contains the basic information, users can decide if it is necessary to read the details after reading it. For some experiment data which have already been included by other websites, only the summary and links to the experiment data are given. In the user's interface, the summary can be given as above table.

Author:

The topic is the full information of the experiment participants. For validation, the experiments made by experienced experts are more reliable and can bring more confidences to the code.

The main participants	<p>The experts who made the experiment. If necessary, the links to personal website of those experts can be provided by SUSANA web.</p> <p>Experiment made by experienced and famous scientist is more reliable. If the users are not quite familiar with the scientists, the links provided by the SUSANA website can help the users making their own judgment.</p> <p>Normally, the names of the experts attended in the experiment are mentioned in the experiment report. However, It is quite possible that the information about the participants is missed due to some reasons. So, such item can be kept in blank in the submitting phase.</p>
The experiment time	<p>Start and end dates of the experiment.</p> <p>As the improvement of the technology, the accuracy and types of the experimental instrumentations have been improved a lot. So, exact dates of the experiment can express the quantity of the experiment data partially.</p> <p>Similarly to the name of scientists, date of the experiment can be missed in the submitting phase.</p>

The relevant agencies	<p>The agencies (universities, research institutes and companies) attended in the experiment. If necessary, the links to the official websites of those agencies can be provided.</p> <p>Similarly, experiments made by professional agencies are more reliable. The name and links of the relevant provided in the sub-topic can help the users making their own evaluation for the data quality.</p> <p>Similarly, the topic about the experiment related agencies can be kept in blank in the submitting phase.</p>
The place of the experiment	<p>The location (the country, state, institute) of the experiment.</p> <p>Some agencies may have several experimental institutes, and the quality of the experiment facilities might be different. Providing where the experiment was made can partially prove the quality of the experiment data.</p> <p>Location of the experiment even has less importance than the information of scientists, date and agencies, so this topic can be kept in blank in the submitting phase as well.</p>
*The data provider	<p>The person provided the experiment to SUSANA website.</p> <p>Under the consideration of the data revise and answering the questions from the users, providing the name of publishers is quite necessary.</p> <p>The name of the provider is very important for the maintenance of the article, it is better to provide the information in the submitting phase. For convenience, such information can be added by the system automatically.</p>

Experimental setup:

The topic is the detailed description for the experiment facility and instrumentation. Such information is quite important for the establishment of computational domain in simulation.

Components	<p>The main components of the experimental facilities. Some experimental facilities may have several components (like A1 and A3 in KIT), number of the components should be given in this part.</p> <p>For the simulation with multi-block method, information and number of the facility components can be a reference for the construction of computational domain.</p>
------------	---

	<p>Some experimental facilities only have simple geometry, so the component information is not necessary for every article. Such sub-topic can be kept in blank in the submitting phase.</p>
<p>**Boundary geometry</p>	<p>Geometrical information for special boundary such as the fan, the release source and ignition point.</p> <ul style="list-style-type: none"> - The type of the boundary (source, velocity, pressure) - The size of such special boundary (can be given in the latter facility drawing) - The location of the special boundary (can be given in the latter facility drawing) <p>Establishment of the boundaries can dominate the final result of numerical simulation. No one will doubt the necessity of boundary setting message.</p> <p>Description of the boundary is quite necessary for the construction of computational domain, so such message must be given in the submitting phase. During the review, such topic is a key subject.</p>
<p>**Instrumentations</p>	<p>The instrumentations used in this experiment, detailed information should cover:</p> <ul style="list-style-type: none"> - The types of the instrumentations - The numbers of the instrumentations - The position of the instrumentations (can be given in the latter facility drawing) <p>Instrumentations are the data collectors in the experiment, and the validation is done between the data collected by instrumentations and simulation results. Exact information of instrumentations is important factor for the success of validation.</p> <p>Sometimes, the information about the types of the instrumentation might be unavailable, but the position of the instrumentation must be provided in the article. Otherwise, the Validation cannot be done. Such topic is also a key subject in the review phase.</p>
<p>The mutable variables in the facility</p>	<p>Sometimes, geometry may also be a mutable factor in experiment, including</p> <ul style="list-style-type: none"> - The destructible boundary and parameter of the boundary - The mutable geometry in the facility (such as the size of the obstacles is mutable when the influences of the different geometry is studied by the experiment) <p>The mutable factors in the facility are important for the construction of computational domain.</p> <p>If there are no mutable factors in the facility, such</p>

	<p>information can be missed in the submitting. If some boundaries are mutable in the experiment, the related information must be provided. This sub-topic is checked by the reviewer.</p>
<p>**Drawing or detailed written description of facility</p>	<p>The detailed description of the experiment facility. All information mentioned above should be included in the drawing.</p> <p>Computational domain should be constructed under the guidance of drawings. Especially for the boundary conditions and the instrumentations, the drawing can show the users their exact sizes and positions. For some simple experiment, detailed description of the facility should be made instead if the drawing is not available.</p> <p>Such topic is very important for the construction of the computational domain. The article without the description of the facility should be rejected.</p>

Information of experiment facility is quite important for the construction of computational domain. In the users interface, such topic can be given as following format:

Components	Component1: description, size
	Component2: description, size
Boundary Geometry	Flow in 01: description, location, size
	Flow out 01: description, location, size
	...
Instrumentations	Type 01: quantities measured, number, locations, ...
	Type 02: quantities measured, number, locations, ...
	Type 03: quantities measured, number, locations, ...
	...
The mutable variables in the facility	Mutable viable 01: positions, the mutable factors
	Mutable viable 02: positions, the mutable factors
	...
Drawing	The detailed figure is provided here. The instrumentations and special boundaries should be marked on the figure.

Objective of the experiment:

In this topic, the purposes of the experiment are given.

Experimental goals	<p>What detailed physical phenomena are planned to be studied by the experiment originally?</p> <p>The original plan of the experiment is the basic information of the experiment data, it is better to provide it to the users.</p> <p>Comparing to the experimental phenomena, the original plan of the experiment may not be important. Such sub-topic can be kept in blank in the submitting phase.</p>
*Phenomena	<p>What physical phenomena can be studied from the experiment results? Those phenomena can be more than or different from the original plan.</p> <p>The phenomena can be studied by the experiment also show what kinds of models can be validated or verified by the experiment.</p> <p>The physical phenomena can be studied by the experiment is one part of the experimental conclusion, so it is better to provide the information in the submitting phase. If no such message is provided by the experiment at all, the topic can be kept in blank in the first submitting. However, the information should be added latterly by the publishers or reviewers.</p>

Applicable calculations:

This topic shows the users what numerical or physical models can be validated or verified by the experiment. Such topic can improve the validation efficiency and help the users making their own judgment about if the experiment is proper for their code.

Fluid governing equations	<p>The transportation equations used to describe the gas dynamics.</p> <p>Such information can be quite useful, but not quite necessary. If no such information is available, it can be kept blank in the submitting phase.</p>
Chemical models	<p>The models used to simulation the chemical reaction.</p> <p>In the cases that no chemical reaction appeared in the experiment or no such information provided by the references, the sub-topic can be blank in the submitting phase.</p>
Boundaries	<p>Numerical method used to simulate the boundary.</p>

	If no such information is available or the numerical treatments are unnecessary, the sub-topic can be kept blank in the submitting phase.
--	---

Experimental procedure:

This topic shows the experimental process, including preparation and detailed experimental phenomena.

**Initial condition	<p>The initial state inside the experiment facility, including</p> <ul style="list-style-type: none"> - Gas species and their ratio - Initial pressure - Initial temperature - Initial velocity - Turbulence parameters <p>All of initial conditions can be given in a template table.</p> <p>For the solution of PDE, proper initial conditions are quite necessary. Without the initial data, validation is impossible. Information as the component of the gas mixture, pressure, temperature and velocity are the basic information for the solution of transportation equation, the turbulence parameters such as turbulence energy, turbulence dissipation and etc. might be optional for some simulation.</p> <p>In the submitting phase, information about the initial state must be given. The reviewers should pay much attention on this part to ensure the initial condition is complete to make the simulation.</p>
**Boundary condition	<p>Some experiments have special boundary conditions such as the source of the gas, velocity inlet or outlet and pressure boundary. Parameters of the boundary should be complete, and the parameters of one boundary can be given by a template table as well.</p> <p>Boundary condition is another necessary factor for the solution of PDE. In the topic of experimental setup information as the type, size and position of these boundaries are provided, and here are the detailed physical parameters of the boundaries. The physical qualities of the boundaries are similar to the initial boundary, but some special boundary may have special requests.</p> <p>Boundary information is another sub-topic must be provided in the submitting phase. For the reviewers, checking the boundary</p>

	conditions is also a very important task they should focus on.
*Descriptions	<p>Some written description for the experiment, including</p> <ul style="list-style-type: none"> - Preparation of the experiment - Experiment procedure - Experiment phenomena - Theoretical analysis - Conclusions <p>The description of the experiment phenomena can help the users selecting proper physical models in the Validation. In addition, comparison between the simulation results and experiment phenomena is a rough validation, it can show if the model can express the real world as well.</p> <p>This sub-topic is usually contained in the collusion part of the experiment. If no written descriptions are available, this sub-topic can be kept in blank in the submitting phase.</p>

In the user's interface, the above information should be given as following (the numbering and classification of components and boundary conditions should be the same as the topic of experiment setup):

Initial condition	<p>Component 01:</p> <p>Temperature-</p> <p>Pressure-</p> <p>Velocity-</p> <p>Gas components-</p> <p>Turbulent parameter-</p>
	<p>Component 01:</p> <p>Temperature-</p> <p>Pressure-</p> <p>Velocity-</p> <p>Gas components-</p> <p>Turbulent parameter-</p>
	...
Boundary conditions	<p>Flow in 01:</p> <p>Temperature-</p>

	Pressure-
	Velocity-
	Gas components-
	Turbulent parameter-
	Flow out 01:
	Temperature-
	Pressure-
	Velocity-
	Gas components-
	Turbulent parameter-
	...
Description	...

Experiment data:

Final experiment results are given in this topic.

*Availability	<p>If the data can be accessed by the public.</p> <p>Show if the data is available to the common readers.</p>
*Description	<p>Some information about the experiment data, including</p> <ul style="list-style-type: none"> - Measurement procedures - Measured quantities - Measure errors - The format of the data file - Description for each data file <p>Basically, description of the experiment data illustrates the contents of the data file. For the cases that several data files are provided, the correspondence between the data files and experiments conditions are given by the description. In addition, the description of the experiment data can show the reliability of the data. The data with less uncertainty can bring more confidence to the code in Validation. It is better to have such information.</p> <p>Such message is strongly recommend. However, since the information is not critical for the numerical simulation, such sub-</p>

	topic can be kept blank in the submitting phase.
**Experiment data	<p>The final result, experiment data collected under different conditions can be shown in different sub-topics.</p> <p>The most important part in the validation, on one will doubt its importance. Such part must be given in the submitting of the article.</p> <p>There is no doubt that the experimental data is the core of the article, this topic must be given in the submitting phase.</p>
Figure	<p>Time dependent figure of the quantities measured by the instrumentations. Figures should be classified by the instrumentation types or physical quantities, and each figure should be marked by the position.</p> <p>The time dependent figures can also express the experiment phenomena, the figures can be useful supplement for the above description.</p> <p>The Figures can be provided by some literature or made by the publishers. If the written description can be provided in the submitting, it is strongly recommend providing some figures as well. If there is no written description, figures are provided if there are some existing ones.</p>
Video	<p>Videos can express the experiment phenomena objectively.</p> <ul style="list-style-type: none"> - Overview of the experiment facility - Preparation of the experiment - Detailed experiment phenomena <p>Similarly, the video of the experiment phenomena can also be useful supplement for the written description.</p> <p>Where the videos about the experiment are available, publishers can submit them to the website.</p>

In the user's interface, the experiment data should be given as following format:

Availability	...
Description	...
Data	<p>File_001 download Figures_001 download Movies_001 download</p> <p>File_002 download Figures_002 download Movies_002 download</p>

	<p>.....</p> <p>download all</p>
--	--

The PDF file containing the information expect performed simulation will be given along with the experiment data file.

Performed simulation:

In this topic, some code validation examples are shown. For each example, the sub-topics should be as following:

Author	<p>The people or agencies attended in the validation.</p> <p>Under the consideration of the user's privacy, this topic can be blank.</p>
*Validation code	<p>The code validated or verified by the experiment.</p> <p>If the validation code is very famous and the result is good enough, the reliability of the experiment data can be proved.</p> <p>The administrator has the right to decide which validation results can be given as example, the chosen ones should be as complete as possible. The validation code can be very critical factor for the selection of validation example.</p>
Mathematical treatments	<p>The mathematical methods used to make the data processing.</p> <p>For some experiments which provides large amount of data, the information in this sub-topics can be great help for the users who are not good at mathematics.</p> <p>Not all the experiment data requires further mathematical treatments, so the topic can be kept blank in the submitting phase.</p>
*Setting of domain	<p>The setting of the computational domain in this validation, including</p> <ul style="list-style-type: none"> - Grid structure and resolution - Construction of the geometry - Initial condition - Establishment of the boundary conditions - Properties of the physical boundary - Figures of the domain <p>All these information can be provided in a table.</p> <p>As example, the methodology used in the numerical simulation is very important. For the other users such information can help</p>

	<p>saving large amount of working efforts.</p> <p>The purpose of providing examples is to guide the user making their validation more efficient. Therefore, the results provided as example should have the information about the domain setting, or the results are not proper and should be rejected.</p>
*Validation Models	<p>The numerical models validated or verified by the experiment data.</p> <p>The example should be as complete as possible and the validation models are critical information for the users, so the sub-topic should not be empty.</p>
*Validation results	<p>The validation results, including:</p> <ul style="list-style-type: none"> - Figures - Conclusion <p>Comparison with the experiment data is the best proof for the quality of the experiment data. The results can also show the other users the validation criteria.</p> <p>The validation example should have the validation result and conclusion, or the administrator can reject it.</p>

In the user's interface, each simulation example is given by a individual table. As shown in following:

Performed simulation 01:

Author	...
*Validation code	...
Mathematical treatments	...
*Setting of domain	...
*Validation Models	...
*Validation results	...
download	

Performed simulation 02:

Author	...
*Validation code	...
Mathematical treatments	...
*Setting of domain	...

*Validation Models	...
*Validation results	...
download	

...

References:

*References about the experiment from the participants	<p>The reports and papers published by the experiment participants, including:</p> <ul style="list-style-type: none"> - Reports or papers about the experiment - Analysis for the experiment - Validation made by the experiment participants <p>For the users who need more detailed illustration of the experiment, the references are important.</p> <p>At least the source of the data should be provided.</p>
References about the experiment from the third party	<p>The reports and papers published by third party related to the experiment, including:</p> <ul style="list-style-type: none"> - Reports or papers about the repeatability of the experiment - Analysis for the experiment - Validation made by the third party <p>The Validation works or repeat experiments made by the third party are good evaluation for the experiment data. It is quit recommended to have this sub-topic in the article.</p> <p>If no such information is available the topic can be kept blank. Latter, if some validation works are done based on the experiment, information can be added by the administrators.</p>

Comments:

Inside the topic some comments from the users are listed, the comments can be displayed by time.

Remark:

**): The mark means the topics must be contained in the article, without the topics the validation is impossible.

*): The mark means the information contained in the topics can assist the validation, it is better to have such topics.

Black words: the name of the topic and what should be included in the topic.

Red words: the reason why such information should be given on the website and provided to the readers (users).

Blue words: the necessity of the topic and if the topic can be remained blank in the submitting phase.

all rights reserved

Appendix II

In this appendix, summary of all the experiments on the website are given.

Release & Distribution:

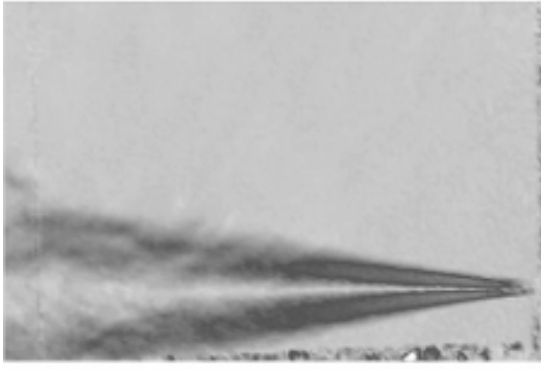
Experiment Name	Low Temperature Jet
Experiment Type	Release
Keywords	Release, Low Temperature, High Pressure,
Draft drawing or simple description for the facility	
Short description	Horizontal hydrogen jets released at different temperatures and different pressure.

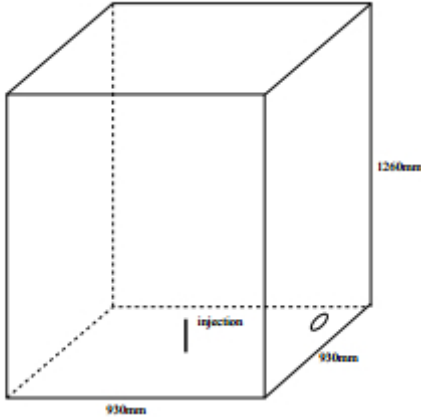
Experiment Name	Gamelan_300NL_A
Experiment Type	Dispersion
Keywords	Dispersion, Venting, Helium
Draft drawing or simple description for the facility	
Short description	Validation experiments were carried out at CEA in the enclosure with sizes $H \times W \times L = 1.26 \times 0.93 \times 0.93$ m with one vent located on a wall. Vents were located at a wall opposite to that where sensors are located. The release of helium was directed

	vertically upward from a pipe with internal diameter 20 mm located 21 cm above the centre of the floor.
--	---

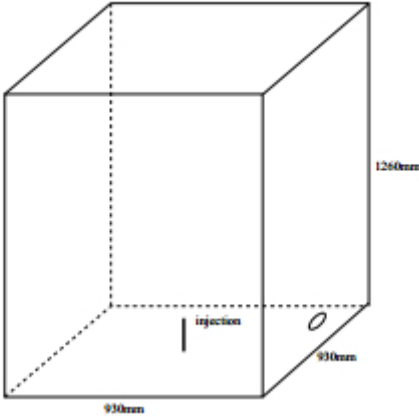
Experiment Name	Gamelan_180NL_B
Experiment Type	Dispersion
Keywords	Dispersion, Venting, Helium
Draft drawing or simple description for the facility	
Short description	Validation experiments were carried out at CEA in the enclosure with sizes $H \times W \times L = 1.26 \times 0.93 \times 0.93$ m with one vent located on a wall. Vents were located at a wall opposite to that where sensors are located. The release of helium was directed vertically upward from a pipe with internal diameter 5 mm located 21 cm above the centre of the floor.

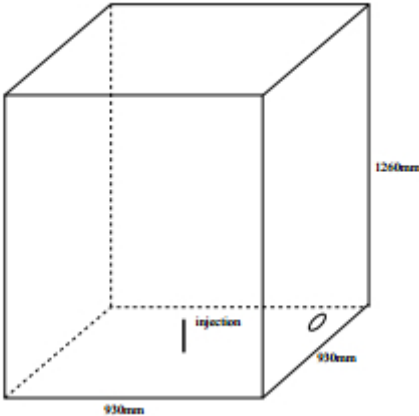
Experiment Name	Gamelan_60NL_A
Experiment Type	Dispersion
Keywords	Dispersion, Venting, Helium
Draft drawing or simple description for the facility	

Short description	Validation experiments were carried out at CEA in the enclosure with sizes HxWxL=1.26x0.93x0.93 m with one vent located on a wall. The release of helium was directed vertically upwards from a pipe with internal diameter 20 mm located 21 cm above the centre of the floor.
-------------------	--

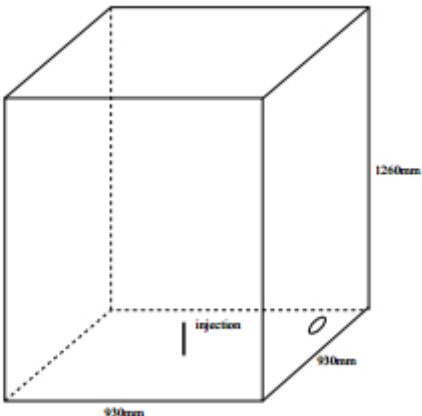
Experiment Name	Gamelan_60NL_B
Experiment Type	Dispersion
Keywords	Dispersion, Venting, Helium
Draft drawing or simple description for the facility	
Short description	Validation experiments were carried out at CEA in the enclosure with sizes HxWxL=1.26x0.93x0.93 m with one vent located on a wall. The release of helium was directed vertically upwards from a pipe with internal diameter 20 mm located 21 cm above the centre of the floor.

Experiment Name	Gamelan_60NL_C
Experiment Type	Dispersion
Keywords	Dispersion, Venting, Helium

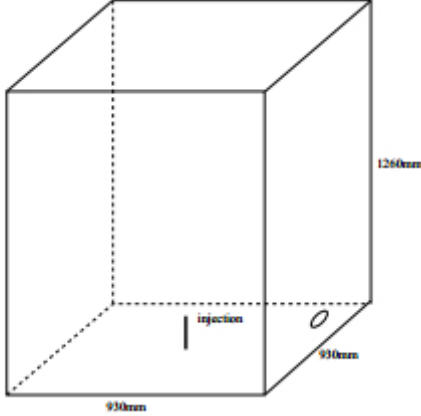
<p>Draft drawing or simple description for the facility</p>	
<p>Short description</p>	<p>Validation experiments were carried out at CEA in the enclosure with sizes HxWxL=1.26x0.93x0.93 m with one vent located on a wall. The release of helium was directed vertically upwards from a pipe with internal diameter 20 mm located 21 cm above the centre of the floor.</p>

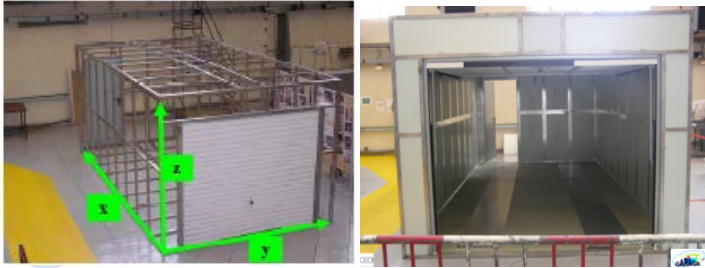
<p>Experiment Name</p>	<p>SPEB_V21</p>	
<p>Experiment Type</p>	<p>Dispersion</p>	
<p>Keywords</p>	<p>Dispersion, Large-scaled Experiment, Helium</p>	
<p>Draft drawing or simple description for the facility</p>		
<p>Short description</p>	<p>The GARAGE facility is representative of a realistic single vehicle private garage. The GARAGE facility is situated indoors to attenuate the variations in meteorological conditions. The internal volume of GARAGE is 40.92 m³. Continuous injection of helium is installed in this big volume GARAGE.</p>	

<p>Experiment Name</p>	<p>GEXCON 06</p>	
<p>Experiment Type</p>	<p>Dispersion</p>	
<p>Keywords</p>	<p>Jet, Dispersion, Obstacles, Venting</p>	

Draft drawing or simple description for the facility	
Short description	<p>The experimental rig consists of a 1.20 m x 0.20 m x 0.90 m vessel, divided into compartments by use of 4 baffle plates with dimensions 0.30 m x 0.20 m. There is one vent opening at the wall opposite the release location centrally located.</p>

Experiment Name	GEXCON 27
Experiment Type	Dispersion
Keywords	Jet, Dispersion, Obstacles, Venting
Draft drawing or simple description for the facility	
Short description	<p>The experimental rig consists of a 1.20 m x 0.20 m x 0.90 m vessel, divided into compartments by use of 4 baffle plates with dimensions 0.30 m x 0.20 m. There is one vent opening at the wall opposite the release location centrally located.</p>

Experiment Name	GEXCON 58
-----------------	-----------

Experiment Type	Dispersion
Keywords	Jet, Dispersion, Obstacles, Venting
Draft drawing or simple description for the facility	
Short description	The experimental rig consists of a 1.20 m x 0.20 m x 0.90 m vessel, divided into compartments by use of 4 baffle plates with dimensions 0.30 m x 0.20 m. There is one vent opening at the wall opposite the release location centrally located.

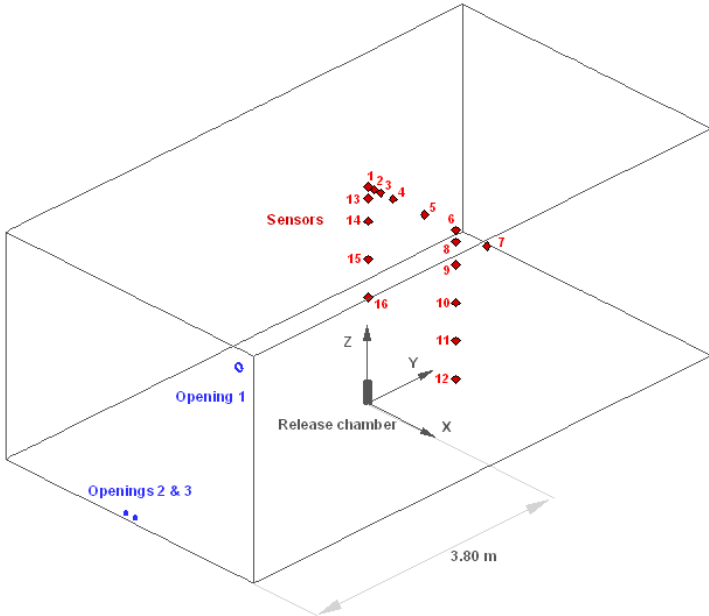
Experiment Name	INERIS-6
Experiment Type	Dispersion
Keywords	Dispersion, Small Inflow, Large Volume, Venting
Draft drawing or simple description for the facility	

Short description	The experiment INERIS-TEST-6C, performed within the InsHyde project by INERIS, consisting of a 1 g/s vertical hydrogen release for 240 s from an orifice of 20mm diameter into a rectangular room (garage) of dimensions 3.78 X 7.2 X 2.88m in width, length and height respectively. Two small openings at the bottom of the front side of the room assured constant pressure conditions.
-------------------	--

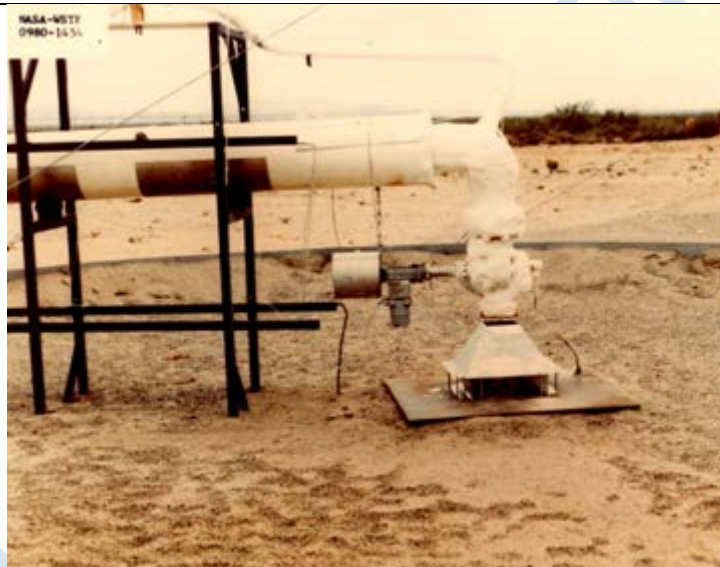
Experiment Name	NASA-6C
Experiment Type	Dispersion
Keywords	Liquid Hydrogen, Dispersion, Wind, Open Atmosphere
Draft drawing or simple description for the facility	
Short description	The experiments consisted of ground spills of up to 5.7 m ³ of liquid hydrogen (402 kg), with spill durations of approximately 35 seconds. Instrumented towers located downwind of the spill site gathered data on the temperature, hydrogen concentration and turbulence levels.

Experiment Name	SBEP_1_WP8
Experiment Type	Dispersion
Keywords	Dispersion, Subsonic Release, Closed Vessel

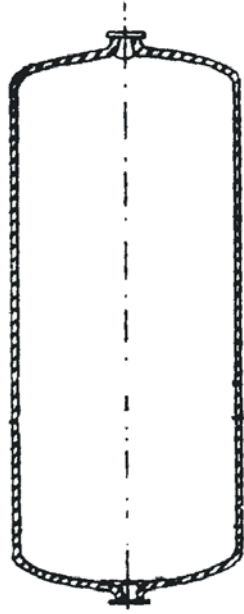
Draft drawing or simple description for the facility	
Short description	A subsonic release of hydrogen in a closed vessel with height 5.5 m, diameter 2.2 m and volume 20 m ³ . Then the concentrations of hydrogen are detected by 6 sensors installed at the central line of the vessel.

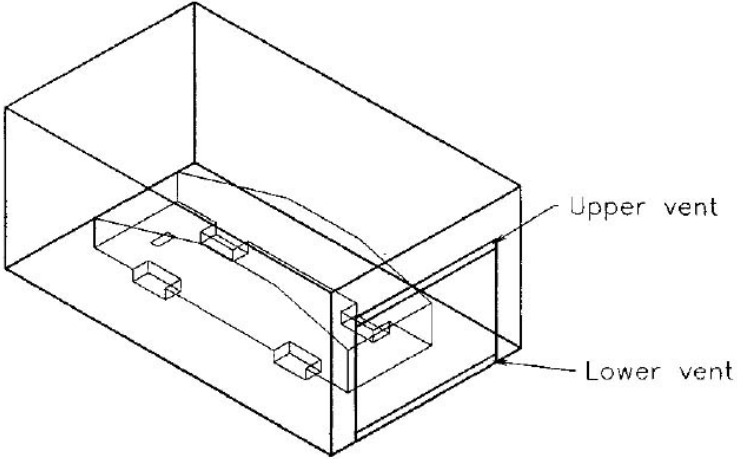
Experiment Name	SWAIN_GARAGE
Experiment Type	Dispersion
Keywords	Dispersion, Helium, Complicated Geometry, Venting
Draft drawing or simple description for the facility	
Short description	The experimental facility represents a full-scale single car garage with dimensions 6.4 X 3.7 X 2.8 m and two vents on the door. Vent openings with varying height were examined. A full-scale plywood model vehicle was placed inside the garage. The helium flow rate was

	7200 l/h and the release lasted 2 h.
--	--------------------------------------

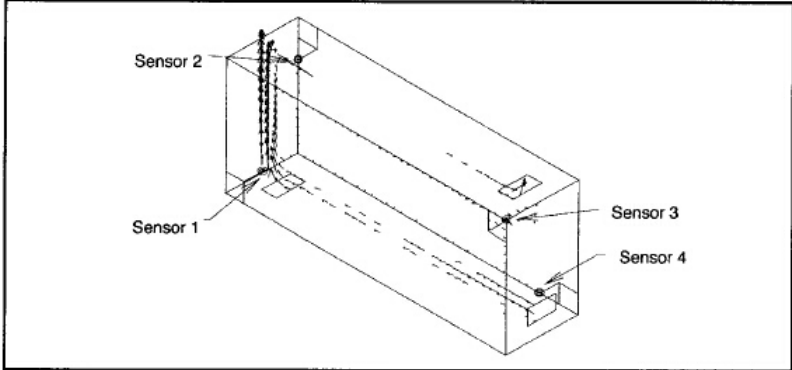
Experiment Name	SWAIN_HALLWAY
Experiment Type	Dispersion
Keywords	Dispersion, Confined Volume, Venting
Draft drawing or simple description for the facility	
Short description	In the vented hallway experiment, the hydrogen leaks from the floor at the left end of a hallway with the dimension of 2.9 m × 0.74 m × 1.22 m. At the right end of the hallway, there are a roof vent and a lower door vent for the gas ventilation. The hydrogen leak is at 2 SCFM (Standard Cubic Feet per Minute) and for a period of 20 minutes.

Experiment Name	HSL-Test 5
Experiment Type	Dispersion
Keywords	Liquid hydrogen, Dispersion, Open Environment

<p>Draft drawing or simple description for the facility</p>	
<p>Short description</p>	<p>LH2 (liquid hydrogen) is released horizontally along ground through a 26.6 mm orifice. The ground is concrete. The spill rate is 60lt/min and the spill duration is 248 sec. Average wind speed at 2.5 m height is about 2.7 m/s and average wind direction is in line with the release.</p>

<p>Experiment Name</p>	<p>HSL-Test 6</p>
<p>Experiment Type</p>	<p>Dispersion</p>
<p>Keywords</p>	<p>Liquid hydrogen, Dispersion, Open Environment</p>
<p>Draft drawing or simple description for the facility</p>	
<p>Short description</p>	<p>LH2 (liquid hydrogen) is released vertically 100 mm above the ground through a 26.6 mm orifice. The ground is concrete. The spill rate is 60lt/min and the spill duration is 556 sec. Average wind speed at 2.5 m height is 3.35 m/s and average wind</p>

	direction is in line with the release.
--	--

Experiment Name	HSL-Test 7
Experiment Type	Dispersion
Keywords	Liquid hydrogen, dispersion, open environment
Draft drawing or simple description for the facility	
Short description	LH2 (liquid hydrogen) is released horizontally 860 mm above the ground through a 26.6 mm orifice. The ground is concrete. The spill rate is 60lt/min and the spill duration is 305 sec. Average wind speed at 2.5 m height is about 3 m/s and average wind direction is in line with the release.

Experiment Name	KIT HIWP4-001
Experiment Type	Pressure peaking phenomena (PPP)
Keywords	Helium, Unignited Release, Pressure Peaking Phenomenon
Draft drawing or simple description for the facility	The test facility was installed inside the same Test-Chamber for the experimental campaign at the Hydrogen Test Centre HYKA KIT. The Test-Chamber has the dimensions 5.5x8.5x3.4 m ³ with a volume of approx. 160 m ³ . Figure shows a drawing of the test chamber with its different levels and a sketch of the experimental facility. The facility itself mainly consists of a cubic enclosure with the inner dimensions of 100x960x980 mm ³ (HxWxD), which is made from aluminium profile rails that are covered with two transparent and four solid metal plates.

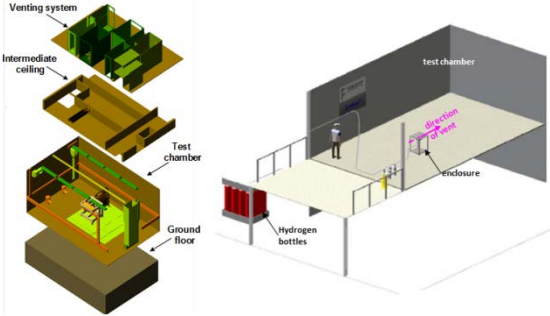
	
<p>Short description</p>	<p>The series of experiments were performed to investigate and confirm the pressure peaking phenomena (PPP), discovered earlier analytically.</p> <p>Helium release Flow rate: 0.2172 g/s Orifice size: 5 mm Vent Configuration: Top vent 1 cm²</p>

<p>Experiment Name</p>	<p>KIT HIWP4-002</p>
<p>Experiment Type</p>	<p>Pressure peaking phenomena (PPP)</p>
<p>Keywords</p>	<p>Hydrogen, Unignited Release, Pressure Peaking Phenomenon</p>
<p>Draft drawing or simple description for the facility</p>	<p>The test facility was installed inside the same Test-Chamber for the experimental campaign at the Hydrogen Test Centre HYKA KIT. The Test-Chamber has the dimensions 5.5x8.5x3.4 m³ with a volume of approx. 160 m³. Figure shows a drawing of the test chamber with its different levels and a sketch of the experimental facility. The facility itself mainly consists of a cubic enclosure with the inner dimensions of 100x960x980 mm³ (HxWxD), which is made from aluminium profile rails that are covered with two transparent and four solid metal plates.</p>

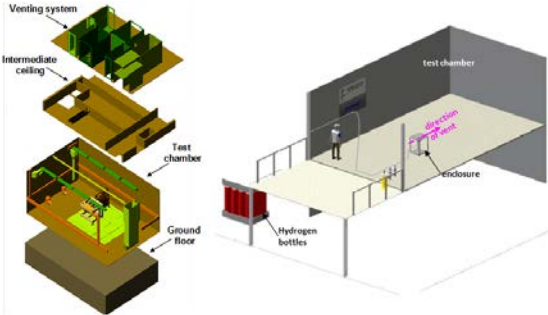
	
Short description	<p>The series of experiments were performed to investigate and confirm the pressure peaking phenomena (PPP), discovered earlier analytically.</p> <p>Hydrogen release</p> <p>Flow rate: 0.1086 g/s</p> <p>Orifice size: 5 mm</p> <p>Vent Configuration: Top vent 1 cm²</p>

Experiment Name	KIT HIWP4-003
Experiment Type	Pressure peaking phenomena (PPP)
Keywords	Hydrogen, Unignited Release, Pressure Peaking Phenomenon
Draft drawing or simple description for the facility	<p>The test facility was installed inside the same Test-Chamber for the experimental campaign at the Hydrogen Test Centre HYKA KIT. The Test-Chamber has the dimensions 5.5x8.5x3.4 m³ with a volume of approx. 160 m³. Figure shows a drawing of the test chamber with its different levels and a sketch of the experimental facility. The facility itself mainly consists of a cubic enclosure with the inner dimensions of 100x960x980 mm³ (HxWxD), which is made from aluminium profile rails that are covered with two transparent and four solid metal plates.</p>

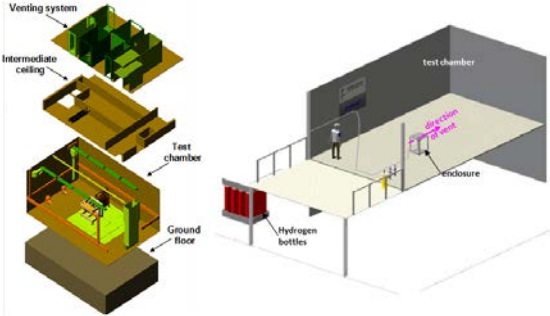
	 <p>The diagram illustrates the experimental setup. On the left, a 3D exploded view shows the 'Venting system' (green), 'Intermediate ceiling' (yellow), 'Test chamber' (orange), and 'Ground floor' (grey). On the right, a perspective view shows the 'test chamber' containing an 'enclosure' (pink) and 'Hydrogen bottles' (red) on the ground floor.</p>
<p>Short description</p>	<p>The series of experiments were performed to investigate and confirm the pressure peaking phenomena (PPP), discovered earlier analytically.</p> <p>Hydrogen release</p> <p>Flow rate: 0.5486 g/s</p> <p>Orifice size: 5 mm</p> <p>Vent Configuration: Top vent 2 cm²</p>

<p>Experiment Name</p>	<p>KIT HIWP4-004</p>
<p>Experiment Type</p>	<p>Pressure peaking phenomena (PPP)</p>
<p>Keywords</p>	<p>Helium, Unignited release, Pressure Peaking Phenomenon</p>
<p>Draft drawing or simple description for the facility</p>	<p>The test facility was installed inside the same Test-Chamber for the experimental campaign at the Hydrogen Test Centre HYKA KIT. The Test-Chamber has the dimensions 5.5x8.5x3.4 m³ with a volume of approx. 160 m³. Figure shows a drawing of the test chamber with its different levels and a sketch of the experimental facility. The facility itself mainly consists of a cubic enclosure with the inner dimensions of 100x960x980 mm³ (HxWxD), which is made from aluminium profile rails that are covered with two transparent and four solid metal plates.</p>

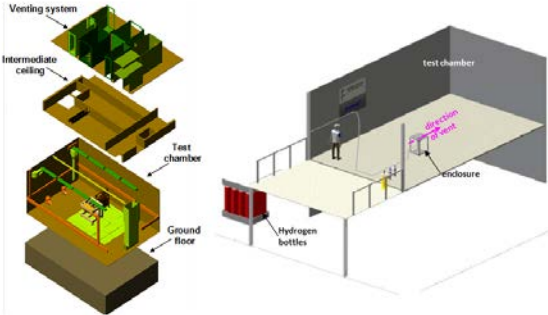
	
Short description	<p>The series of experiments were performed to investigate and confirm the pressure peaking phenomena (PPP), discovered earlier analytically.</p> <p>Helium release</p> <p>Flow rate: 0.1086 g/s</p> <p>Orifice size: 5 mm</p> <p>Vent Configuration: Top vent 1 cm²</p>

Experiment Name	KIT HIWP4-005
Experiment Type	Pressure peaking phenomena (PPP)
Keywords	Hydrogen, Unignited Release, Pressure Peaking Phenomenon
Draft drawing or simple description for the facility	<p>The test facility was installed inside the same Test-Chamber for the experimental campaign at the Hydrogen Test Centre HYKA KIT. The Test-Chamber has the dimensions 5.5x8.5x3.4 m³ with a volume of approx. 160 m³. Figure shows a drawing of the test chamber with its different levels and a sketch of the experimental facility. The facility itself mainly consists of a cubic enclosure with the inner dimensions of 100x960x980 mm³ (HxWxD), which is made from aluminium profile rails that are covered with two transparent and four solid metal plates.</p>

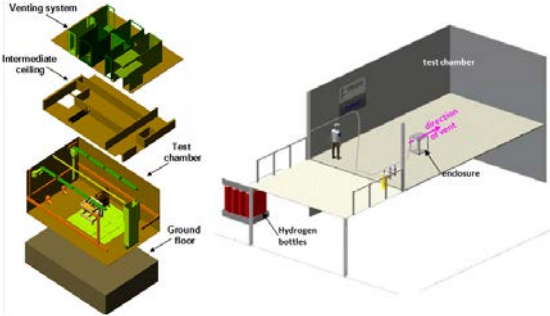
	 <p>The diagram illustrates the experimental setup. On the left, a 3D exploded view shows the 'Venting system' (green), 'Intermediate ceiling' (yellow), 'Test chamber' (orange), and 'Ground floor' (grey). On the right, a perspective view shows the 'test chamber' (grey) containing a 'test enclosure' (pink) and 'Hydrogen bottles' (red) on the ground floor.</p>
<p>Short description</p>	<p>The series of experiments were performed to investigate and confirm the pressure peaking phenomena (PPP), discovered earlier analytically.</p> <p>Hydrogen release</p> <p>Flow rate: 1.086 g/s</p> <p>Orifice size: 5 mm</p> <p>Vent Configuration: Top vent 3 cm²</p>

<p>Experiment Name</p>	<p>KIT HIWP4-006</p>
<p>Experiment Type</p>	<p>Pressure peaking phenomena (PPP)</p>
<p>Keywords</p>	<p>Hydrogen, Unignited Release, Pressure Peaking Phenomenon</p>
<p>Draft drawing or simple description for the facility</p>	<p>The test facility was installed inside the same Test-Chamber for the experimental campaign at the Hydrogen Test Centre HYKA KIT. The Test-Chamber has the dimensions 5.5x8.5x3.4 m³ with a volume of approx. 160 m³. Figure shows a drawing of the test chamber with its different levels and a sketch of the experimental facility. The facility itself mainly consists of a cubic enclosure with the inner dimensions of 100x960x980 mm³ (HxWxD), which is made from aluminium profile rails that are covered with two transparent and four solid metal plates.</p>

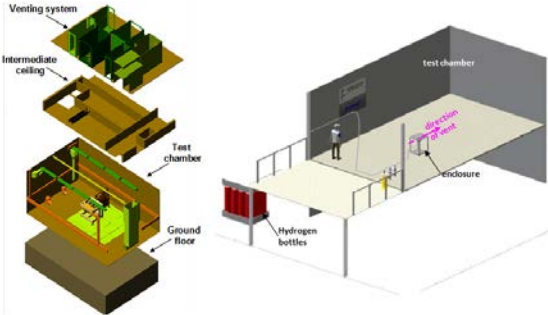
	
Short description	<p>The series of experiments were performed to investigate and confirm the pressure peaking phenomena (PPP), discovered earlier analytically.</p> <p>Hydrogen release</p> <p>Flow rate: 0.215 g/s</p> <p>Orifice size: 5 mm</p> <p>Vent Configuration: Top vent 1 cm²</p>

Experiment Name	KIT HIWP4-040
Experiment Type	Pressure peaking phenomena (PPP)
Keywords	Helium, Unignited Release, Pressure Peaking Phenomenon
Draft drawing or simple description for the facility	<p>The test facility was installed inside the same Test-Chamber for the experimental campaign at the Hydrogen Test Centre HYKA KIT. The Test-Chamber has the dimensions 5.5x8.5x3.4 m³ with a volume of approx. 160 m³. Figure shows a drawing of the test chamber with its different levels and a sketch of the experimental facility. The facility itself mainly consists of a cubic enclosure with the inner dimensions of 100x960x980 mm³ (HxWxD), which is made from aluminium profile rails that are covered with two transparent and four solid metal plates.</p>

<p>Short description</p>	<p>The series of experiments were performed to investigate and confirm the pressure peaking phenomena (PPP), discovered earlier analytically.</p> <p>Helium release</p> <p>Flow rate: 0.22 g/s</p> <p>Orifice size: 5 mm</p> <p>Vent Configuration: Top vent 1 cm²</p>

Ignition & Fire:

<p>Experiment Name</p>	<p>PRD</p>
<p>Experiment Type</p>	<p>Ignition</p>
<p>Keywords</p>	<p>Auto Ignition, High Pressure Release,</p>
<p>Draft drawing or simple description for the facility</p>	
<p>Short description</p>	<p>In order to investigate the spontaneous of hydrogen, the pressurized tube with a T shaped pressure relief devices were</p>

	used. In the experiment, the tube was filled with different pressure to investigate the relation between the pressure and ignition.
--	---

Experiment Name	Indoor jet fire WP4/1
Experiment Type	Experimental studies of indoor jet fire dynamics
Keywords	Jet fire, High Pressure Release, Indoor, Well-ventilated
Draft drawing or simple description for the facility	<p>A carbon steel enclosure with an internal volume of approximately 31 m³ (2.5 m by 2.5 m by 5 m) was used. The enclosure was situated in the open air and so exposed to the weather during the experiments. Five passive vents (each 0.83 m wide and 0.27 m high) were located on the side walls. The vents could be fully or partially closed using steel plates and gaskets, or left open to the atmosphere. The walls are made from 6 mm thick steel plates and appear flat when viewed from inside, while the exterior features a number of more substantial horizontal and vertical structural beams. Two emergency explosion relief vents (total area 1.6 m²) made from 100 µm aluminium foil were fitted in the roof. The enclosure is raised off the ground by 0.8 m.</p>
Short description	<p>This experiment has been carried out to investigate the behaviour of hydrogen jet fires within enclosures fitted with passive ventilation.</p> <p>Release type: Choked</p> <p>Flow rate: 149 NI/min</p> <p>Orifice size: 0.55 mm</p> <p>Vent Configuration: 1 upper vent, Vent 1 (0.87m x 0.23m)</p>

Experiment Name	Indoor jet fire WP4/2
Experiment Type	Experimental studies of indoor jet fire dynamics
Keywords	Jet fire, Subsonic, Indoor, Well-ventilated
Draft drawing or simple description for the facility	<p>A carbon steel enclosure with an internal volume of approximately 31 m³ (2.5 m by 2.5 m by 5 m) was used. The enclosure was situated in the open air and so exposed to the weather during the experiments. Five passive vents (each 0.83 m wide and 0.27 m high) were located on the side walls. The vents could be fully or partially closed using steel plates and gaskets, or left open to the atmosphere. The walls are made from 6 mm thick steel plates and appear flat when viewed from inside, while the exterior features a number of more substantial horizontal and vertical structural beams. Two emergency explosion relief vents (total area 1.6 m²) made from 100 µm aluminium foil were fitted in the roof. The enclosure is raised off the ground by 0.8 m.</p> <p>Circular roof vent, same area as rectangular vents, diameter 0.535m</p> <p>5 m</p> <p>~ 0.1 m below inner ceiling of enclosure</p> <p>~ 0.1 m from end</p> <p>0.83m</p> <p>0.27 m high</p> <p>~ 0.1 m above inner floor of enclosure</p> <p>0.5 m above enclosure floor</p> <p>Enclosure 2.5 m high, 2.5 m wide and 5m long</p>
Short description	<p>This experiment has been carried out to investigate the behaviour of hydrogen jet fires within enclosures fitted with passive ventilation.</p> <p>Release type: Subsonic</p> <p>Flow rate: 150 NI/min</p> <p>Orifice size: 10 mm</p> <p>Vent Configuration: 1 upper vent, Vent 1 (0.87m x 0.23m)</p>

Experiment Name	Indoor jet fire WP4/3
Experiment Type	Experimental studies of indoor jet fire dynamics
Keywords	Jet fire, High Pressure Release, Indoor, Well-ventilated

<p>Draft drawing or simple description for the facility</p>	<p>A carbon steel enclosure with an internal volume of approximately 31 m³ (2.5 m by 2.5 m by 5 m) was used. The enclosure was situated in the open air and so exposed to the weather during the experiments. Five passive vents (each 0.83 m wide and 0.27 m high) were located on the side walls. The vents could be fully or partially closed using steel plates and gaskets, or left open to the atmosphere. The walls are made from 6 mm thick steel plates and appear flat when viewed from inside, while the exterior features a number of more substantial horizontal and vertical structural beams. Two emergency explosion relief vents (total area 1.6 m²) made from 100 µm aluminium foil were fitted in the roof. The enclosure is raised off the ground by 0.8 m.</p>
<p>Short description</p>	<p>This experiment has been carried out to investigate the behaviour of hydrogen jet fires within enclosures fitted with passive ventilation.</p> <p>Release type: Choked</p> <p>Flow rate: 293 NI/min</p> <p>Orifice size: 0.9 mm</p> <p>Vent Configuration: 1 upper vent V5, 1 lower vent V4 (each 0.87m x 0.23m)</p>

<p>Experiment Name</p>	<p>Indoor jet fire WP4/4</p>
<p>Experiment Type</p>	<p>Experimental studies of indoor jet fire dynamics</p>
<p>Keywords</p>	<p>Jet fire, High Pressure Release, Indoor, Well-ventilated</p>
<p>Draft drawing or simple description for the facility</p>	<p>A carbon steel enclosure with an internal volume of approximately 31 m³ (2.5 m by 2.5 m by 5 m) was used. The enclosure was situated in the open air and so exposed to the weather during the experiments. Five passive vents (each 0.83 m wide and 0.27 m high) were located on the side walls. The</p>

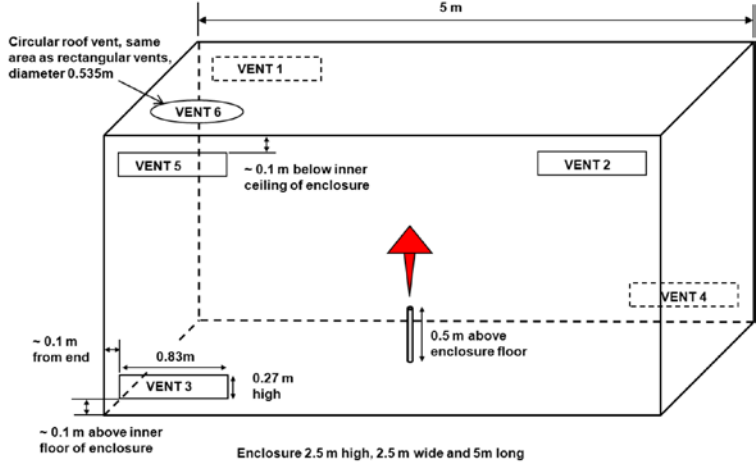
	<p>vents could be fully or partially closed using steel plates and gaskets, or left open to the atmosphere. The walls are made from 6 mm thick steel plates and appear flat when viewed from inside, while the exterior features a number of more substantial horizontal and vertical structural beams. Two emergency explosion relief vents (total area 1.6 m²) made from 100 µm aluminium foil were fitted in the roof. The enclosure is raised off the ground by 0.8 m.</p>  <p>Enclosure 2.5 m high, 2.5 m wide and 5m long</p>
<p>Short description</p>	<p>This experiment has been carried out to investigate the behaviour of hydrogen jet fires within enclosures fitted with passive ventilation.</p> <p>Release type: Choked</p> <p>Flow rate: 581 NI/min</p> <p>Orifice size: 0.9 mm</p> <p>Vent Configuration: 1 upper vent V5, 1 lower vent V4 (each 0.87m x 0.23m)</p>

<p>Experiment Name</p>	<p>Indoor jet fire WP4/5</p>
<p>Experiment Type</p>	<p>Experimental studies of indoor jet fire dynamics</p>
<p>Keywords</p>	<p>Jet fire, High Pressure Release, Indoor, Well-ventilated</p>
<p>Draft drawing or simple description for the facility</p>	<p>A carbon steel enclosure with an internal volume of approximately 31 m³ (2.5 m by 2.5 m by 5 m) was used. The enclosure was situated in the open air and so exposed to the weather during the experiments. Five passive vents (each 0.83 m wide and 0.27 m high) were located on the side walls. The vents could be fully or partially closed using steel plates and gaskets, or left open to the atmosphere. The walls are made from 6 mm thick steel plates and appear flat when viewed from inside, while the exterior features a number of more substantial horizontal and vertical structural beams. Two emergency</p>

	<p>explosion relief vents (total area 1.6 m²) made from 100 µm aluminium foil were fitted in the roof. The enclosure is raised off the ground by 0.8 m.</p>
<p>Short description</p>	<p>This experiment has been carried out to investigate the behaviour of hydrogen jet fires within enclosures fitted with passive ventilation.</p> <p>Release type: Choked</p> <p>Flow rate: 891 NI/min</p> <p>Orifice size: 0.9 mm</p> <p>Vent Configuration: 1 upper vent V5, 1 lower vent V4 (each 0.87m x 0.23m)</p>

<p>Experiment Name</p>	<p>Indoor jet fire WP4/6</p>
<p>Experiment Type</p>	<p>Experimental studies of indoor jet fire dynamics</p>
<p>Keywords</p>	<p>Jet fire, High Pressure Release, Indoor, Well-ventilated</p>
<p>Draft drawing or simple description for the facility</p>	<p>A carbon steel enclosure with an internal volume of approximately 31 m³ (2.5 m by 2.5 m by 5 m) was used. The enclosure was situated in the open air and so exposed to the weather during the experiments. Five passive vents (each 0.83 m wide and 0.27 m high) were located on the side walls. The vents could be fully or partially closed using steel plates and gaskets, or left open to the atmosphere. The walls are made from 6 mm thick steel plates and appear flat when viewed from inside, while the exterior features a number of more substantial horizontal and vertical structural beams. Two emergency explosion relief vents (total area 1.6 m²) made from 100 µm aluminium foil were fitted in the roof. The enclosure is raised off the ground by 0.8 m.</p>

	<p>Circular roof vent, same area as rectangular vents, diameter 0.535m</p> <p>5 m</p> <p>VENT 1</p> <p>VENT 6</p> <p>VENT 5</p> <p>~ 0.1 m below inner ceiling of enclosure</p> <p>VENT 2</p> <p>VENT 4</p> <p>0.5 m above enclosure floor</p> <p>0.83 m</p> <p>0.27 m high</p> <p>~ 0.1 m from end</p> <p>~ 0.1 m above inner floor of enclosure</p> <p>Enclosure 2.5 m high, 2.5 m wide and 5 m long</p>
<p>Short description</p>	<p>This experiment has been carried out to investigate the behaviour of hydrogen jet fires within enclosures fitted with passive ventilation.</p> <p>Release type: Choked</p> <p>Flow rate: 648 NI/min</p> <p>Orifice size: 0.9 mm</p> <p>Vent Configuration: 1 upper vent V1, 1 lower vent V3 (each 0.87m x 0.23m)</p>

<p>Experiment Name</p>	<p>Indoor jet fire WP4/7</p>
<p>Experiment Type</p>	<p>Experimental studies of indoor jet fire dynamics</p>
<p>Keywords</p>	<p>Jet fire, Indoor, Well-ventilated</p>
<p>Draft drawing or simple description for the facility</p>	<p>A carbon steel enclosure with an internal volume of approximately 31 m³ (2.5 m by 2.5 m by 5 m) was used. The enclosure was situated in the open air and so exposed to the weather during the experiments. Five passive vents (each 0.83 m wide and 0.27 m high) were located on the side walls. The vents could be fully or partially closed using steel plates and gaskets, or left open to the atmosphere. The walls are made from 6 mm thick steel plates and appear flat when viewed from inside, while the exterior features a number of more substantial horizontal and vertical structural beams. Two emergency explosion relief vents (total area 1.6 m²) made from 100 µm aluminium foil were fitted in the roof. The enclosure is raised off the ground by 0.8 m.</p>

	<p>Circular roof vent, same area as rectangular vents, diameter 0.535m</p> <p>5 m</p> <p>VENT 1</p> <p>VENT 2</p> <p>~ 0.1 m below inner ceiling of enclosure</p> <p>0.5 m above enclosure floor</p> <p>~ 0.1 m from end</p> <p>0.83 m</p> <p>0.27 m high</p> <p>VENT 3</p> <p>VENT 4</p> <p>~ 0.1 m above inner floor of enclosure</p> <p>Enclosure 2.5 m high, 2.5 m wide and 5m long</p>
<p>Short description</p>	<p>This experiment has been carried out to investigate the behaviour of hydrogen jet fires within enclosures fitted with passive ventilation.</p> <p>Release type: Subsonic</p> <p>Flow rate: 648 NI/min</p> <p>Orifice size: 10 mm</p> <p>Vent Configuration: 2 upper vent V1, 1 lower vent V3 (each 0.87m x 0.23m)</p>

<p>Experiment Name</p>	<p>Indoor jet fire WP4/8</p>
<p>Experiment Type</p>	<p>Experimental studies of indoor jet fire dynamics</p>
<p>Keywords</p>	<p>Jet fire, Indoor, Well-ventilated</p>
<p>Draft drawing or simple description for the facility</p>	<p>A carbon steel enclosure with an internal volume of approximately 31 m³ (2.5 m by 2.5 m by 5 m) was used. The enclosure was situated in the open air and so exposed to the weather during the experiments. Five passive vents (each 0.83 m wide and 0.27 m high) were located on the side walls. The vents could be fully or partially closed using steel plates and gaskets, or left open to the atmosphere. The walls are made from 6 mm thick steel plates and appear flat when viewed from inside, while the exterior features a number of more substantial horizontal and vertical structural beams. Two emergency explosion relief vents (total area 1.6 m²) made from 100 µm aluminium foil were fitted in the roof. The enclosure is raised off the ground by 0.8 m.</p>

	<p>Circular roof vent, same area as rectangular vents, diameter 0.535m</p> <p>5 m</p> <p>VENT 1</p> <p>VENT 6</p> <p>VENT 5</p> <p>~ 0.1 m below inner ceiling of enclosure</p> <p>VENT 2</p> <p>VENT 4</p> <p>0.5 m above enclosure floor</p> <p>~ 0.1 m from end</p> <p>0.83 m</p> <p>0.27 m high</p> <p>~ 0.1 m above inner floor of enclosure</p> <p>Enclosure 2.5 m high, 2.5 m wide and 5 m long</p>
<p>Short description</p>	<p>This experiment has been carried out to investigate the behaviour of hydrogen jet fires within enclosures fitted with passive ventilation.</p> <p>Release type: Subsonic</p> <p>Flow rate: 891 NI/min</p> <p>Orifice size: 10 mm</p> <p>Vent Configuration: 3 upper vent V1, 1 lower vent V3 (each 0.87m x 0.23m)</p>

<p>Experiment Name</p>	<p>Indoor jet fire WP4/10</p>
<p>Experiment Type</p>	<p>Experimental studies of indoor jet fire dynamics</p>
<p>Keywords</p>	<p>Jet fire, Indoor, Well-ventilated</p>
<p>Draft drawing or simple description for the facility</p>	<p>A carbon steel enclosure with an internal volume of approximately 31 m³ (2.5 m by 2.5 m by 5 m) was used. The enclosure was situated in the open air and so exposed to the weather during the experiments. Five passive vents (each 0.83 m wide and 0.27 m high) were located on the side walls. The vents could be fully or partially closed using steel plates and gaskets, or left open to the atmosphere. The walls are made from 6 mm thick steel plates and appear flat when viewed from inside, while the exterior features a number of more substantial horizontal and vertical structural beams. Two emergency explosion relief vents (total area 1.6 m²) made from 100 µm aluminium foil were fitted in the roof. The enclosure is raised off the ground by 0.8 m.</p>

	<p>Circular roof vent, same area as rectangular vents, diameter 0.535m</p> <p>5 m</p> <p>VENT 1</p> <p>VENT 2</p> <p>~ 0.1 m below inner ceiling of enclosure</p> <p>0.5 m above enclosure floor</p> <p>~ 0.1 m from end</p> <p>0.83 m</p> <p>0.27 m high</p> <p>VENT 3</p> <p>VENT 4</p> <p>~ 0.1 m above inner floor of enclosure</p> <p>Enclosure 2.5 m high, 2.5 m wide and 5 m long</p>
<p>Short description</p>	<p>This experiment has been carried out to investigate the behaviour of hydrogen jet fires within enclosures fitted with passive ventilation.</p> <p>Release type: Subsonic</p> <p>Flow rate: 800 NI/min</p> <p>Orifice size: 10 mm</p> <p>Vent Configuration: 25% upper vent V1 only (0.21m x 0.27m)</p>

<p>Experiment Name</p>	<p>Indoor jet fire WP4/11</p>
<p>Experiment Type</p>	<p>Experimental studies of indoor jet fire dynamics</p>
<p>Keywords</p>	<p>Jet fire, Indoor, Well-ventilated</p>
<p>Draft drawing or simple description for the facility</p>	<p>A carbon steel enclosure with an internal volume of approximately 31 m³ (2.5 m by 2.5 m by 5 m) was used. The enclosure was situated in the open air and so exposed to the weather during the experiments. Five passive vents (each 0.83 m wide and 0.27 m high) were located on the side walls. The vents could be fully or partially closed using steel plates and gaskets, or left open to the atmosphere. The walls are made from 6 mm thick steel plates and appear flat when viewed from inside, while the exterior features a number of more substantial horizontal and vertical structural beams. Two emergency explosion relief vents (total area 1.6 m²) made from 100 µm aluminium foil were fitted in the roof. The enclosure is raised off the ground by 0.8 m.</p>

	<p>Circular roof vent, same area as rectangular vents, diameter 0.535m</p> <p>5 m</p> <p>VENT 1</p> <p>VENT 6</p> <p>VENT 5</p> <p>~ 0.1 m below inner ceiling of enclosure</p> <p>VENT 2</p> <p>VENT 4</p> <p>0.5 m above enclosure floor</p> <p>0.27 m high</p> <p>0.83 m</p> <p>~ 0.1 m from end</p> <p>~ 0.1 m above inner floor of enclosure</p> <p>Enclosure 2.5 m high, 2.5 m wide and 5 m long</p>
<p>Short description</p>	<p>This experiment has been carried out to investigate the behaviour of hydrogen jet fires within enclosures fitted with passive ventilation.</p> <p>Release type: Subsonic</p> <p>Flow rate: 800 NI/min</p> <p>Orifice size: 10 mm</p> <p>Vent Configuration: 50% upper vent V1 only (0.42m x 0.27m)</p>

<p>Experiment Name</p>	<p>Indoor jet fire WP4/12</p>
<p>Experiment Type</p>	<p>Experimental studies of indoor jet fire dynamics</p>
<p>Keywords</p>	<p>Jet fire, Indoor, Well-ventilated</p>
<p>Draft drawing or simple description for the facility</p>	<p>A carbon steel enclosure with an internal volume of approximately 31 m³ (2.5 m by 2.5 m by 5 m) was used. The enclosure was situated in the open air and so exposed to the weather during the experiments. Five passive vents (each 0.83 m wide and 0.27 m high) were located on the side walls. The vents could be fully or partially closed using steel plates and gaskets, or left open to the atmosphere. The walls are made from 6 mm thick steel plates and appear flat when viewed from inside, while the exterior features a number of more substantial horizontal and vertical structural beams. Two emergency explosion relief vents (total area 1.6 m²) made from 100 µm aluminium foil were fitted in the roof. The enclosure is raised off the ground by 0.8 m.</p>

	<p>Circular roof vent, same area as rectangular vents, diameter 0.535m</p> <p>5 m</p> <p>VENT 1</p> <p>VENT 6</p> <p>VENT 5</p> <p>~ 0.1 m below inner ceiling of enclosure</p> <p>VENT 2</p> <p>VENT 4</p> <p>0.5 m above enclosure floor</p> <p>~ 0.1 m from end</p> <p>0.83 m</p> <p>0.27 m high</p> <p>VENT 3</p> <p>~ 0.1 m above inner floor of enclosure</p> <p>Enclosure 2.5 m high, 2.5 m wide and 5 m long</p>
<p>Short description</p>	<p>This experiment has been carried out to investigate the behaviour of hydrogen jet fires within enclosures fitted with passive ventilation.</p> <p>Release type: Subsonic</p> <p>Flow rate: 800 NI/min</p> <p>Orifice size: 10 mm</p> <p>Vent Configuration: 25% upper vent V1 only (0.21m x 0.27m)</p>

<p>Experiment Name</p>	<p>Indoor jet fire KIT HIWP4 07</p>
<p>Experiment Type</p>	<p>Experimental studies of indoor jet fire dynamics</p>
<p>Keywords</p>	<p>Indoor Jet Fire, Self-extinction</p>
<p>Draft drawing or simple description for the facility</p>	<p>The test facility was installed inside the same Test-Chamber for the experimental campaign at the Hydrogen Test Centre HYKA KIT. The Test-Chamber has the dimensions 5.5x8.5x3.4 m³ with a volume of approx. 160 m³. Figure shows a drawing of the test chamber with its different levels and a sketch of the experimental facility. The facility itself mainly consists of a cubic enclosure with the inner dimensions of 100x960x980 mm³ (HxWxD), which is made from aluminium profile rails that are covered with two transparent and four solid metal plates.</p>

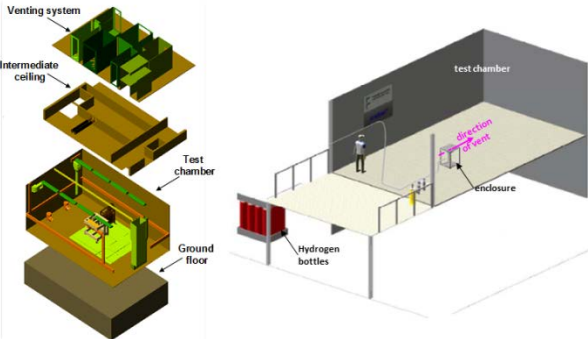
	
<p>Short description</p>	<p>The main focus in the experiments lies on conditions that lead to quenching of an ignited jet in an enclosure due to the reduction of the oxygen concentration during the combustion.</p> <p>Flow rate: 0.215 g/s</p> <p>Orifice size: 5 mm</p> <p>Vent Configuration: 1 cm²</p>

<p>Experiment Name</p>	<p>Indoor jet fire KIT HIWP4 08</p>
<p>Experiment Type</p>	<p>Experimental studies of indoor jet fire dynamics</p>
<p>Keywords</p>	<p>Indoor Jet Fire, Self-extinction</p>
<p>Draft drawing or simple description for the facility</p>	<p>The test facility was installed inside the same Test-Chamber for the experimental campaign at the Hydrogen Test Centre HYKA KIT. The Test-Chamber has the dimensions 5.5x8.5x3.4 m³ with a volume of approx. 160 m³. Figure shows a drawing of the test chamber with its different levels and a sketch of the experimental facility. The facility itself mainly consists of a cubic enclosure with the inner dimensions of 100x960x980 mm³ (HxWxD), which is made from aluminium profile rails that are covered with two transparent and four solid metal plates.</p>

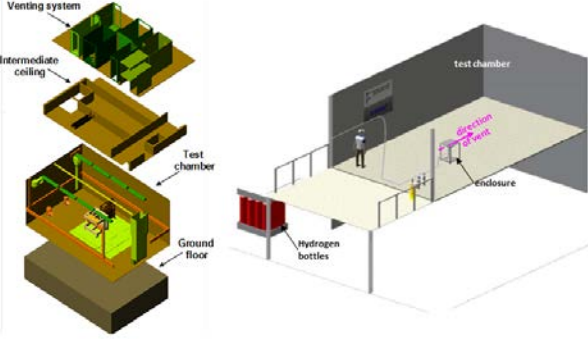
	
Short description	<p>The main focus in the experiments lies on conditions that lead to quenching of an ignited jet in an enclosure due to the reduction of the oxygen concentration during the combustion.</p> <p>Flow rate: 0.5486 g/s</p> <p>Orifice size: 5 mm</p> <p>Vent Configuration: 1 cm²</p>

Experiment Name	Indoor jet fire KIT HIWP4 09
Experiment Type	Experimental studies of indoor jet fire dynamics
Keywords	Indoor Jet Fire, Self-extinction
Draft drawing or simple description for the facility	<p>The test facility was installed inside the same Test-Chamber for the experimental campaign at the Hydrogen Test Centre HYKA KIT. The Test-Chamber has the dimensions 5.5x8.5x3.4 m³ with a volume of approx. 160 m³. Figure shows a drawing of the test chamber with its different levels and a sketch of the experimental facility. The facility itself mainly consists of a cubic enclosure with the inner dimensions of 100x960x980 mm³ (HxWxD), which is made from aluminium profile rails that are covered with two transparent and four solid metal plates.</p>

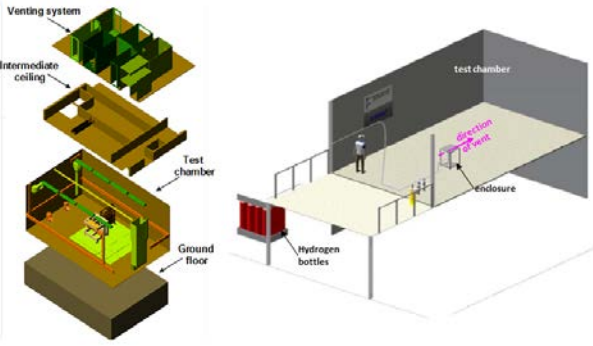
	
Short description	<p>The main focus in the experiments lies on conditions that lead to quenching of an ignited jet in an enclosure due to the reduction of the oxygen concentration during the combustion.</p> <p>Flow rate: 0.1086 g/s</p> <p>Orifice size: 5 mm</p> <p>Vent Configuration: 1 cm²</p>

Experiment Name	Indoor jet fire KIT HIWP4 10
Experiment Type	Experimental studies of indoor jet fire dynamics
Keywords	Indoor Jet Fire, Self-extinction
Draft drawing or simple description for the facility	<p>The test facility was installed inside the same Test-Chamber for the experimental campaign at the Hydrogen Test Centre HYKA KIT. The Test-Chamber has the dimensions 5.5x8.5x3.4 m³ with a volume of approx. 160 m³. Figure shows a drawing of the test chamber with its different levels and a sketch of the experimental facility. The facility itself mainly consists of a cubic enclosure with the inner dimensions of 100x960x980 mm³ (HxWxD), which is made from aluminium profile rails that are covered with two transparent and four solid metal plates.</p>

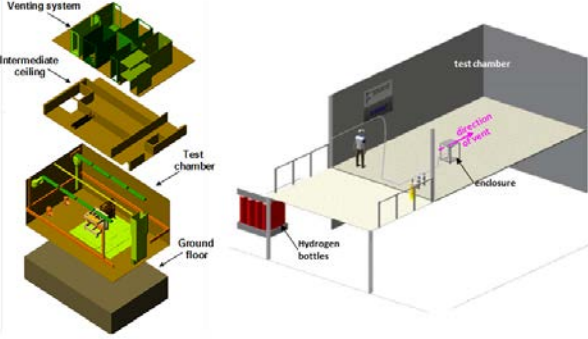
	
Short description	<p>The main focus in the experiments lies on conditions that lead to quenching of an ignited jet in an enclosure due to the reduction of the oxygen concentration during the combustion.</p> <p>Flow rate: 0.1086 g/s</p> <p>Orifice size: 5 mm</p> <p>Vent Configuration: 1 cm²</p>

Experiment Name	Indoor jet fire KIT HIWP4 11
Experiment Type	Experimental studies of indoor jet fire dynamics
Keywords	Indoor Jet Fire, Self-extinction
Draft drawing or simple description for the facility	<p>The test facility was installed inside the same Test-Chamber for the experimental campaign at the Hydrogen Test Centre HYKA KIT. The Test-Chamber has the dimensions 5.5x8.5x3.4 m³ with a volume of approx. 160 m³. Figure shows a drawing of the test chamber with its different levels and a sketch of the experimental facility. The facility itself mainly consists of a cubic enclosure with the inner dimensions of 100x960x980 mm³ (HxWxD), which is made from aluminium profile rails that are covered with two transparent and four solid metal plates.</p>

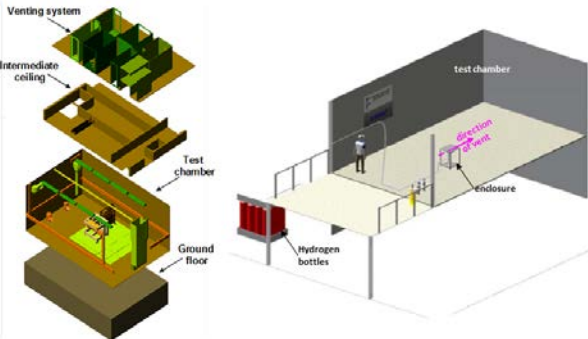
	
Short description	<p>The main focus in the experiments lies on conditions that lead to quenching of an ignited jet in an enclosure due to the reduction of the oxygen concentration during the combustion.</p> <p>Flow rate: 0.5486 g/s</p> <p>Orifice size: 5 mm</p> <p>Vent Configuration: 1 cm²</p>

Experiment Name	Indoor jet fire KIT HIWP4 12
Experiment Type	Experimental studies of indoor jet fire dynamics
Keywords	Indoor Jet Fire, Self-extinction
Draft drawing or simple description for the facility	<p>The test facility was installed inside the same Test-Chamber for the experimental campaign at the Hydrogen Test Centre HYKA KIT. The Test-Chamber has the dimensions 5.5x8.5x3.4 m³ with a volume of approx. 160 m³. Figure shows a drawing of the test chamber with its different levels and a sketch of the experimental facility. The facility itself mainly consists of a cubic enclosure with the inner dimensions of 100x960x980 mm³ (HxWxD), which is made from aluminium profile rails that are covered with two transparent and four solid metal plates.</p>

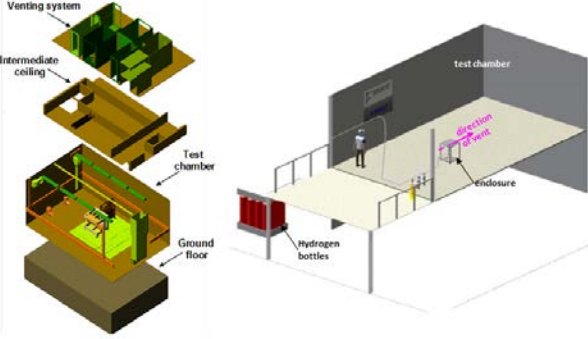
	
Short description	<p>The main focus in the experiments lies on conditions that lead to quenching of an ignited jet in an enclosure due to the reduction of the oxygen concentration during the combustion.</p> <p>Flow rate: 1.086 g/s</p> <p>Orifice size: 5 mm</p> <p>Vent Configuration: 1 cm²</p>

Experiment Name	Indoor jet fire KIT HIWP4 13
Experiment Type	Experimental studies of indoor jet fire dynamics
Keywords	Indoor Jet Fire, Self-extinction
Draft drawing or simple description for the facility	<p>The test facility was installed inside the same Test-Chamber for the experimental campaign at the Hydrogen Test Centre HYKA KIT. The Test-Chamber has the dimensions 5.5x8.5x3.4 m³ with a volume of approx. 160 m³. Figure shows a drawing of the test chamber with its different levels and a sketch of the experimental facility. The facility itself mainly consists of a cubic enclosure with the inner dimensions of 100x960x980 mm³ (HxWxD), which is made from aluminium profile rails that are covered with two transparent and four solid metal plates.</p>

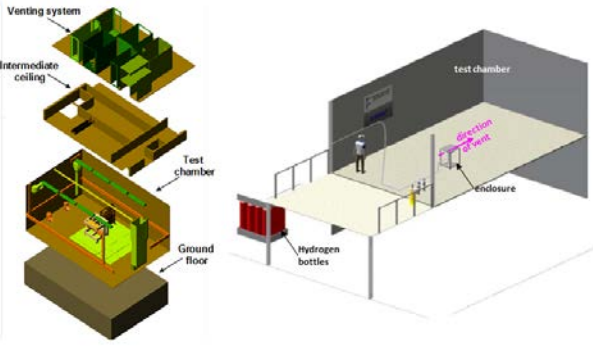
	
Short description	<p>The main focus in the experiments lies on conditions that lead to quenching of an ignited jet in an enclosure due to the reduction of the oxygen concentration during the combustion.</p> <p>Flow rate: 0.5486 g/s</p> <p>Orifice size: 5 mm</p> <p>Vent Configuration: Upper horizontal vent 3x15 cm</p>

Experiment Name	Indoor jet fire KIT HIWP4 14
Experiment Type	Experimental studies of indoor jet fire dynamics
Keywords	Indoor Jet Fire, Self-extinction
Draft drawing or simple description for the facility	<p>The test facility was installed inside the same Test-Chamber for the experimental campaign at the Hydrogen Test Centre HYKA KIT. The Test-Chamber has the dimensions 5.5x8.5x3.4 m³ with a volume of approx. 160 m³. Figure shows a drawing of the test chamber with its different levels and a sketch of the experimental facility. The facility itself mainly consists of a cubic enclosure with the inner dimensions of 100x960x980 mm³ (HxWxD), which is made from aluminium profile rails that are covered with two transparent and four solid metal plates.</p>

<p>Short description</p>	<p>The main focus in the experiments lies on conditions that lead to quenching of an ignited jet in an enclosure due to the reduction of the oxygen concentration during the combustion.</p> <p>Flow rate: 0.5486 g/s</p> <p>Orifice size: 5 mm</p> <p>Vent Configuration: Upper horizontal vent 3x15 cm</p>

<p>Experiment Name</p>	<p>Indoor jet fire KIT HIWP4 15</p>
<p>Experiment Type</p>	<p>Experimental studies of indoor jet fire dynamics</p>
<p>Keywords</p>	<p>Indoor Jet Fire, Self-extinction</p>
<p>Draft drawing or simple description for the facility</p>	<p>The test facility was installed inside the same Test-Chamber for the experimental campaign at the Hydrogen Test Centre HYKA KIT. The Test-Chamber has the dimensions 5.5x8.5x3.4 m³ with a volume of approx. 160 m³. Figure shows a drawing of the test chamber with its different levels and a sketch of the experimental facility. The facility itself mainly consists of a cubic enclosure with the inner dimensions of 100x960x980 mm³ (HxWxD), which is made from aluminium profile rails that are covered with two transparent and four solid metal plates.</p>

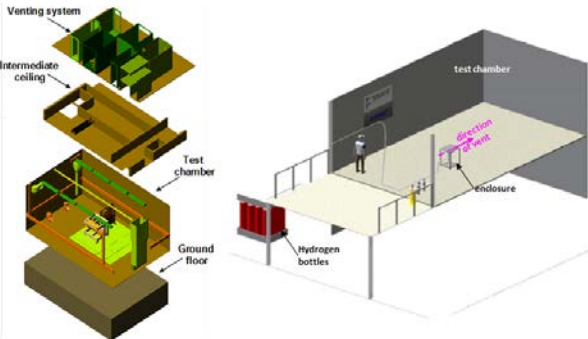
	
<p>Short description</p>	<p>The main focus in the experiments lies on conditions that lead to quenching of an ignited jet in an enclosure due to the reduction of the oxygen concentration during the combustion.</p> <p>Flow rate: 0.1086 g/s</p> <p>Orifice size: 5 mm</p> <p>Vent Configuration: Upper horizontal vent 3x15 cm</p>

<p>Experiment Name</p>	<p>Indoor jet fire KIT HIWP4 16</p>
<p>Experiment Type</p>	<p>Experimental studies of indoor jet fire dynamics</p>
<p>Keywords</p>	<p>Indoor Jet Fire, Self-extinction</p>
<p>Draft drawing or simple description for the facility</p>	<p>The test facility was installed inside the same Test-Chamber for the experimental campaign at the Hydrogen Test Centre HYKA KIT. The Test-Chamber has the dimensions 5.5x8.5x3.4 m³ with a volume of approx. 160 m³. Figure shows a drawing of the test chamber with its different levels and a sketch of the experimental facility. The facility itself mainly consists of a cubic enclosure with the inner dimensions of 100x960x980 mm³ (HxWxD), which is made from aluminium profile rails that are covered with two transparent and four solid metal plates.</p>

<p>Short description</p>	<p>The main focus in the experiments lies on conditions that lead to quenching of an ignited jet in an enclosure due to the reduction of the oxygen concentration during the combustion.</p> <p>Flow rate: 1.086 g/s</p> <p>Orifice size: 5 mm</p> <p>Vent Configuration: Upper horizontal vent 3x15 cm</p>

<p>Experiment Name</p>	<p>Indoor jet fire KIT HIWP4 17</p>
<p>Experiment Type</p>	<p>Experimental studies of indoor jet fire dynamics</p>
<p>Keywords</p>	<p>Indoor Jet Fire, Self-extinction</p>
<p>Draft drawing or simple description for the facility</p>	<p>The test facility was installed inside the same Test-Chamber for the experimental campaign at the Hydrogen Test Centre HYKA KIT. The Test-Chamber has the dimensions 5.5x8.5x3.4 m³ with a volume of approx. 160 m³. Figure shows a drawing of the test chamber with its different levels and a sketch of the experimental facility. The facility itself mainly consists of a cubic enclosure with the inner dimensions of 100x960x980 mm³ (HxWxD), which is made from aluminium profile rails that are covered with two transparent and four solid metal plates.</p>

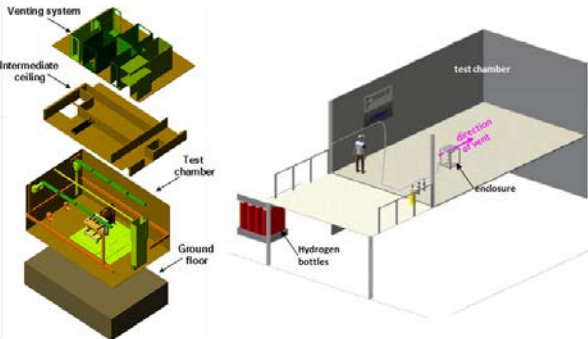
	
<p>Short description</p>	<p>The main focus in the experiments lies on conditions that lead to quenching of an ignited jet in an enclosure due to the reduction of the oxygen concentration during the combustion.</p> <p>Flow rate: 1.086 g/s</p> <p>Orifice size: 5 mm</p> <p>Vent Configuration: Upper horizontal vent 3x30 cm</p>

<p>Experiment Name</p>	<p>Indoor jet fire KIT HIWP4 18</p>
<p>Experiment Type</p>	<p>Experimental studies of indoor jet fire dynamics</p>
<p>Keywords</p>	<p>Indoor Jet Fire, Self-extinction, Re-ignition</p>
<p>Draft drawing or simple description for the facility</p>	<p>The test facility was installed inside the same Test-Chamber for the experimental campaign at the Hydrogen Test Centre HYKA KIT. The Test-Chamber has the dimensions 5.5x8.5x3.4 m³ with a volume of approx. 160 m³. Figure shows a drawing of the test chamber with its different levels and a sketch of the experimental facility. The facility itself mainly consists of a cubic enclosure with the inner dimensions of 100x960x980 mm³ (HxWxD), which is made from aluminium profile rails that are covered with two transparent and four solid metal plates.</p>

<p>Short description</p>	<p>The main focus in the experiments lies on conditions that lead to quenching of an ignited jet in an enclosure due to the reduction of the oxygen concentration during the combustion.</p> <p>Flow rate: 0.5486 g/s</p> <p>Orifice size: 5 mm</p> <p>Vent Configuration: Upper horizontal vent 3x30 cm</p>

<p>Experiment Name</p>	<p>Indoor jet fire KIT HIWP4 19</p>
<p>Experiment Type</p>	<p>Experimental studies of indoor jet fire dynamics</p>
<p>Keywords</p>	<p>Indoor Jet Fire, Well-ventilated</p>
<p>Draft drawing or simple description for the facility</p>	<p>The test facility was installed inside the same Test-Chamber for the experimental campaign at the Hydrogen Test Centre HYKA KIT. The Test-Chamber has the dimensions 5.5x8.5x3.4 m³ with a volume of approx. 160 m³. Figure shows a drawing of the test chamber with its different levels and a sketch of the experimental facility. The facility itself mainly consists of a cubic enclosure with the inner dimensions of 100x960x980 mm³ (HxWxD), which is made from aluminium profile rails that are covered with two transparent and four solid metal plates.</p>

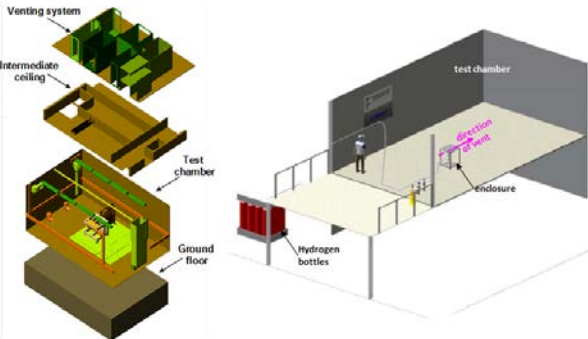
	
<p>Short description</p>	<p>The main focus in the experiments lies on conditions that lead to quenching of an ignited jet in an enclosure due to the reduction of the oxygen concentration during the combustion.</p> <p>Flow rate: 0.1086 g/s</p> <p>Orifice size: 5 mm</p> <p>Vent Configuration: Upper horizontal vent 3x30 cm</p>

<p>Experiment Name</p>	<p>Indoor jet fire KIT HIWP4 20</p>
<p>Experiment Type</p>	<p>Experimental studies of indoor jet fire dynamics</p>
<p>Keywords</p>	<p>Indoor Jet Fire, Self-extinction</p>
<p>Draft drawing or simple description for the facility</p>	<p>The test facility was installed inside the same Test-Chamber for the experimental campaign at the Hydrogen Test Centre HYKA KIT. The Test-Chamber has the dimensions 5.5x8.5x3.4 m³ with a volume of approx. 160 m³. Figure shows a drawing of the test chamber with its different levels and a sketch of the experimental facility. The facility itself mainly consists of a cubic enclosure with the inner dimensions of 100x960x980 mm³ (HxWxD), which is made from aluminium profile rails that are covered with two transparent and four solid metal plates.</p>

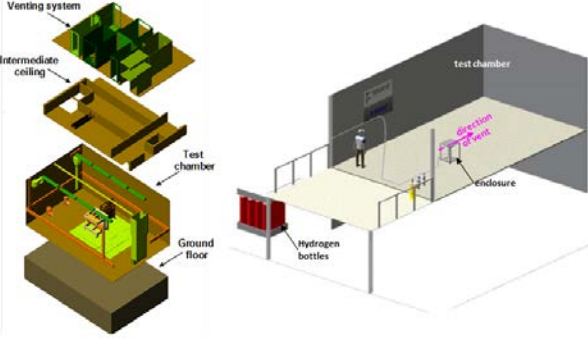
	
Short description	<p>The main focus in the experiments lies on conditions that lead to quenching of an ignited jet in an enclosure due to the reduction of the oxygen concentration during the combustion.</p> <p>Flow rate: 0.5486 g/s</p> <p>Orifice size: 5 mm</p> <p>Vent Configuration: Upper vertical vent 30x3 cm</p>

Experiment Name	Indoor jet fire KIT HIWP4 21
Experiment Type	Experimental studies of indoor jet fire dynamics
Keywords	Indoor Jet Fire, Self-extinction
Draft drawing or simple description for the facility	<p>The test facility was installed inside the same Test-Chamber for the experimental campaign at the Hydrogen Test Centre HYKA KIT. The Test-Chamber has the dimensions 5.5x8.5x3.4 m³ with a volume of approx. 160 m³. Figure shows a drawing of the test chamber with its different levels and a sketch of the experimental facility. The facility itself mainly consists of a cubic enclosure with the inner dimensions of 100x960x980 mm³ (HxWxD), which is made from aluminium profile rails that are covered with two transparent and four solid metal plates.</p>

<p>Short description</p>	<p>The main focus in the experiments lies on conditions that lead to quenching of an ignited jet in an enclosure due to the reduction of the oxygen concentration during the combustion.</p> <p>Flow rate: 1.086 g/s</p> <p>Orifice size: 5 mm</p> <p>Vent Configuration: Upper vertical vent 30x3 cm</p>

<p>Experiment Name</p>	<p>Indoor jet fire KIT HIWP4 35</p>
<p>Experiment Type</p>	<p>Experimental studies of indoor jet fire dynamics</p>
<p>Keywords</p>	<p>Indoor Jet Fire, Self-extinction</p>
<p>Draft drawing or simple description for the facility</p>	<p>The test facility was installed inside the same Test-Chamber for the experimental campaign at the Hydrogen Test Centre HYKA KIT. The Test-Chamber has the dimensions 5.5x8.5x3.4 m³ with a volume of approx. 160 m³. Figure shows a drawing of the test chamber with its different levels and a sketch of the experimental facility. The facility itself mainly consists of a cubic enclosure with the inner dimensions of 100x960x980 mm³ (HxWxD), which is made from aluminium profile rails that are covered with two transparent and four solid metal plates.</p>

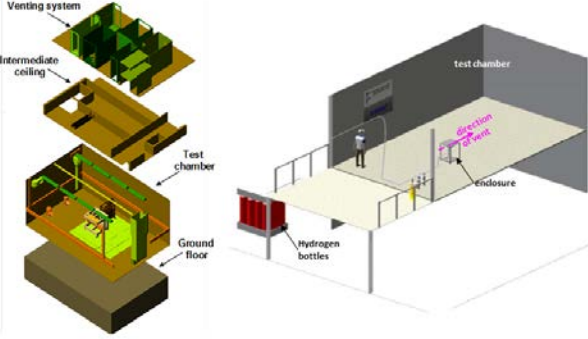
	
Short description	<p>The main focus in the experiments lies on conditions that lead to quenching of an ignited jet in an enclosure due to the reduction of the oxygen concentration during the combustion.</p> <p>Flow rate: 1.086 g/s</p> <p>Orifice size: 5 mm</p> <p>Vent Configuration: Upper horizontal vent 3x30 cm</p>

Experiment Name	Indoor jet fire KIT HIWP4 36
Experiment Type	Experimental studies of indoor jet fire dynamics
Keywords	Indoor Jet Fire, Self-extinction, Re-ignition
Draft drawing or simple description for the facility	<p>The test facility was installed inside the same Test-Chamber for the experimental campaign at the Hydrogen Test Centre HYKA KIT. The Test-Chamber has the dimensions 5.5x8.5x3.4 m³ with a volume of approx. 160 m³. Figure shows a drawing of the test chamber with its different levels and a sketch of the experimental facility. The facility itself mainly consists of a cubic enclosure with the inner dimensions of 100x960x980 mm³ (HxWxD), which is made from aluminium profile rails that are covered with two transparent and four solid metal plates.</p>

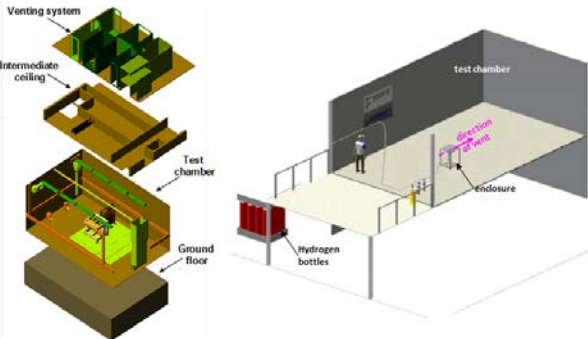
	
<p>Short description</p>	<p>The main focus in the experiments lies on conditions that lead to quenching of an ignited jet in an enclosure due to the reduction of the oxygen concentration during the combustion.</p> <p>Flow rate: 0.5486 g/s</p> <p>Orifice size: 5 mm</p> <p>Vent Configuration: Upper horizontal vent 3x30 cm</p>

<p>Experiment Name</p>	<p>Indoor jet fire KIT HIWP4 37</p>
<p>Experiment Type</p>	<p>Experimental studies of indoor jet fire dynamics</p>
<p>Keywords</p>	<p>Indoor Jet Fire, Self-extinction, Re-ignition</p>
<p>Draft drawing or simple description for the facility</p>	<p>The test facility was installed inside the same Test-Chamber for the experimental campaign at the Hydrogen Test Centre HYKA KIT. The Test-Chamber has the dimensions 5.5x8.5x3.4 m³ with a volume of approx. 160 m³. Figure shows a drawing of the test chamber with its different levels and a sketch of the experimental facility. The facility itself mainly consists of a cubic enclosure with the inner dimensions of 100x960x980 mm³ (HxWxD), which is made from aluminium profile rails that are covered with two transparent and four solid metal plates.</p>

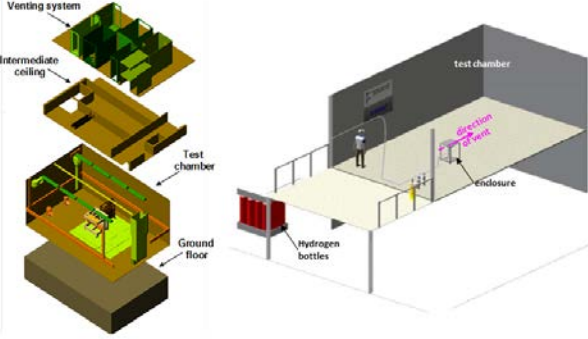
	
<p>Short description</p>	<p>The main focus in the experiments lies on conditions that lead to quenching of an ignited jet in an enclosure due to the reduction of the oxygen concentration during the combustion.</p> <p>Flow rate: 0.1086 g/s</p> <p>Orifice size: 5 mm</p> <p>Vent Configuration: Upper horizontal vent 30x3 cm</p>

Experiment Name	Indoor jet fire KIT HIWP4 57
Experiment Type	Experimental studies of indoor jet fire dynamics
Keywords	Indoor jet fire, Self-extinction, Re-ignition
Draft drawing or simple description for the facility	<p>The test facility was installed inside the same Test-Chamber for the experimental campaign at the Hydrogen Test Centre HYKA KIT. The Test-Chamber has the dimensions 5.5x8.5x3.4 m³ with a volume of approx. 160 m³. Figure shows a drawing of the test chamber with its different levels and a sketch of the experimental facility. The facility itself mainly consists of a cubic enclosure with the inner dimensions of 100x960x980 mm³ (HxWxD), which is made from aluminium profile rails that are covered with two transparent and four solid metal plates.</p>

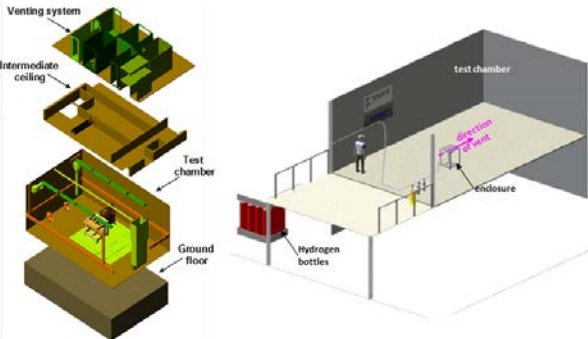
	
<p>Short description</p>	<p>The main focus in the experiments lies on conditions that lead to quenching of an ignited jet in an enclosure due to the reduction of the oxygen concentration during the combustion.</p> <p>Flow rate: 0.1086 g/s</p> <p>Orifice size: 5 mm</p> <p>Vent Configuration: Upper horizontal vent 30x3 cm</p>

<p>Experiment Name</p>	<p>Indoor jet fire KIT HIWP4 58</p>
<p>Experiment Type</p>	<p>Experimental studies of indoor jet fire dynamics</p>
<p>Keywords</p>	<p>Indoor Jet Fire, Self-extinction, Re-ignition</p>
<p>Draft drawing or simple description for the facility</p>	<p>The test facility was installed inside the same Test-Chamber for the experimental campaign at the Hydrogen Test Centre HYKA KIT. The Test-Chamber has the dimensions 5.5x8.5x3.4 m³ with a volume of approx. 160 m³. Figure shows a drawing of the test chamber with its different levels and a sketch of the experimental facility. The facility itself mainly consists of a cubic enclosure with the inner dimensions of 100x960x980 mm³ (HxWxD), which is made from aluminium profile rails that are covered with two transparent and four solid metal plates.</p>

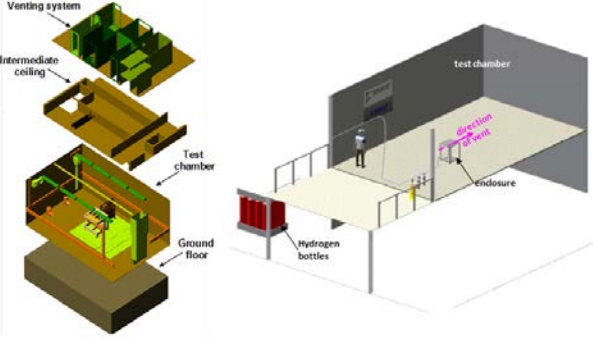
	
Short description	<p>The main focus in the experiments lies on conditions that lead to quenching of an ignited jet in an enclosure due to the reduction of the oxygen concentration during the combustion.</p> <p>Flow rate: 0.5486 g/s</p> <p>Orifice size: 5 mm</p> <p>Vent Configuration: Upper horizontal vent 30x3 cm</p>

Experiment Name	Indoor jet fire KIT HIWP4 59
Experiment Type	Experimental studies of indoor jet fire dynamics
Keywords	Indoor Jet Fire, Well-ventilated, External-flame
Draft drawing or simple description for the facility	<p>The test facility was installed inside the same Test-Chamber for the experimental campaign at the Hydrogen Test Centre HYKA KIT. The Test-Chamber has the dimensions 5.5x8.5x3.4 m³ with a volume of approx. 160 m³. Figure shows a drawing of the test chamber with its different levels and a sketch of the experimental facility. The facility itself mainly consists of a cubic enclosure with the inner dimensions of 100x960x980 mm³ (HxWxD), which is made from aluminium profile rails that are covered with two transparent and four solid metal plates.</p>

<p>Short description</p>	<p>The main focus in the experiments lies on conditions that lead to quenching of an ignited jet in an enclosure due to the reduction of the oxygen concentration during the combustion.</p> <p>Flow rate: 1.086 g/s</p> <p>Orifice size: 5 mm</p> <p>Vent Configuration: Upper and lower horizontal vents 3x15 cm</p>

<p>Experiment Name</p>	<p>Indoor jet fire KIT HIWP4 67</p>
<p>Experiment Type</p>	<p>Experimental studies of indoor jet fire dynamics</p>
<p>Keywords</p>	<p>Indoor Jet Fire, Self-extinction</p>
<p>Draft drawing or simple description for the facility</p>	<p>The test facility was installed inside the same Test-Chamber for the experimental campaign at the Hydrogen Test Centre HYKA KIT. The Test-Chamber has the dimensions 5.5x8.5x3.4 m³ with a volume of approx. 160 m³. Figure shows a drawing of the test chamber with its different levels and a sketch of the experimental facility. The facility itself mainly consists of a cubic enclosure with the inner dimensions of 100x960x980 mm³ (HxWxD), which is made from aluminium profile rails that are covered with two transparent and four solid metal plates.</p>

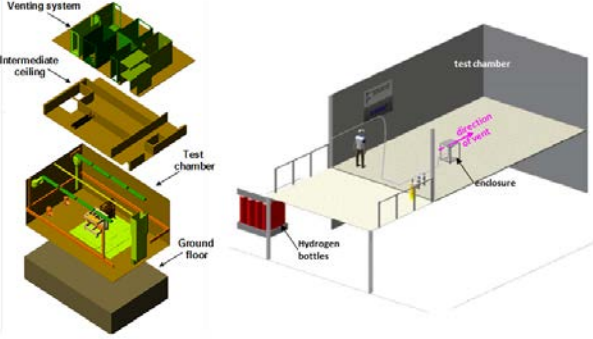
	
<p>Short description</p>	<p>The main focus in the experiments lies on conditions that lead to quenching of an ignited jet in an enclosure due to the reduction of the oxygen concentration during the combustion.</p> <p>Flow rate: 0.1086 g/s</p> <p>Orifice size: 5 mm</p> <p>Vent Configuration: Lower horizontal vent 3x30 cm</p>

Deflagration:

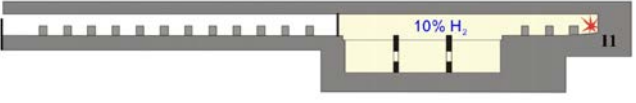
Experiment Name	HYCOM-HYC01
Experiment Type	Deflagration
Keywords	Deflagration, Large-scale Complex Geometry, Obstacles, Flame Acceleration
Draft drawing or simple description for the facility	
Short description	<p>Combustion experiments have been carried out in large scale multi-compartment geometry consisted of curved channel and canyon. Four repeatable obstacles with blockage ratio BR=0.3 installed in the channel and two obstacles in bottom part of canyon. Uniform hydrogen/air mixture with concentration of 10% H₂ was tested.</p>

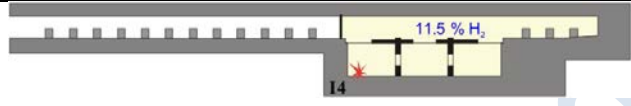
Experiment Name	HYCOM-HYC14
Experiment Type	Deflagration
Keywords	Deflagration, Large-scale Complex Geometry, Obstacles, Flame Acceleration
Draft drawing or simple description for the facility	
Short description	Combustion experiments have been carried out in large scale multi-compartment geometry consisted of curved channel and canyon. Four repeatable obstacles with blockage ratio BR=0.3 installed in the channel. Canyon has been divided in four separate rooms connected with orifices. Uniform hydrogen/air mixture with concentration of 11.5% H ₂ was tested.

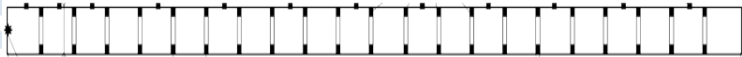
Experiment Name	HYCOM-MC03
Experiment Type	Deflagration
Keywords	Deflagration, Obstacles, Quenching, Closed Tube
Draft drawing or simple description for the facility	
Short description	Combustion experiments have been carried out in obstructed tube of 174 mm in diameter and 12.2 m in length (DRIVER facility). Repeatable obstacles with blockage ratio BR=0.6 at distances equal to diameter. Hydrogen/air mixture with concentration of 10% H ₂ was tested.

Experiment Name	HYCOM-MC12
Experiment Type	Deflagration

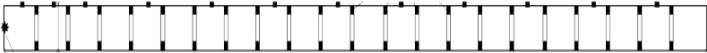
Keywords	Deflagration, Obstacles, Flame Acceleration, Closed Tube
Draft drawing or simple description for the facility	
Short description	Combustion experiments have been carried out in obstructed tube of 174 mm in diameter and 12.2 m in length (DRIVER facility). Repeatable obstacles with blockage ratio BR=0.6 at distances equal to diameter. Hydrogen/air mixture with concentration of 13% H ₂ was tested.

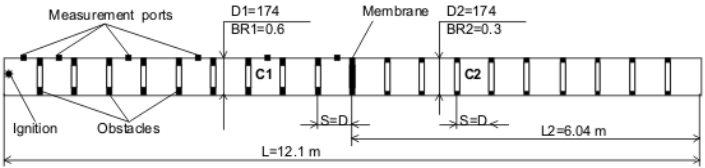
Experiment Name	HYCOM-MC43
Experiment Type	Deflagration
Keywords	Deflagration, Obstacles, None Uniform Hydrogen, Flame Acceleration
Draft drawing or simple description for the facility	
Short description	Combustion experiments have been carried out in obstructed tube of 174 mm in diameter and 12.1 m in length. Repeatable obstacles at distances equal to diameter. The experimental tube was divided in two equal parts by thin polyethylene membrane with different blockage ratios and hydrogen concentrations.

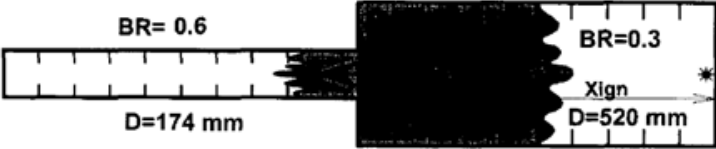
Experiment Name	HYCOM-HC20
Experiment Type	Deflagration
Keywords	Deflagration, Non-uniform Obstructed Tube,
Draft drawing or simple description for the facility	
Short description	Combustion experiments have been carried out in non-uniform obstructed tube of 12.4 m long combined of two parts with

	diameter of 174 and 520 mm in diameter. Combustion of uniform test mixture with 10% of H ₂ in air was investigated.
--	--

Experiment Name	Kumar1983
Experiment Type	Deflagration
Keywords	Deflagration, Uniform Hydrogen Air Mixture , Closed Environment
Draft drawing or simple description for the facility	
Short description	Deflagration of 29.5% (by vol.) hydrogen-air quiescent mixture in the 6.37 m ³ closed spherical vessel (diameter 2.3 m). Central point ignition source. Initial temperature is 373 K, initial pressure 97 kPa.

Experiment Name	HIWP3
Experiment Type	Deflagration
Keywords	Deflagration, Ignition, Venting, Small-scale
Draft drawing of the facility	

Short description	Hydrogen combustion experiments were made in 1 m ³ facility. In the experiments, 18%vol hydrogen-air mixture was prepared in the chamber, ignition points were installed on the rear plate and 50cmX50cm venting was made in the front plate of the cubic test facility.
-------------------	---

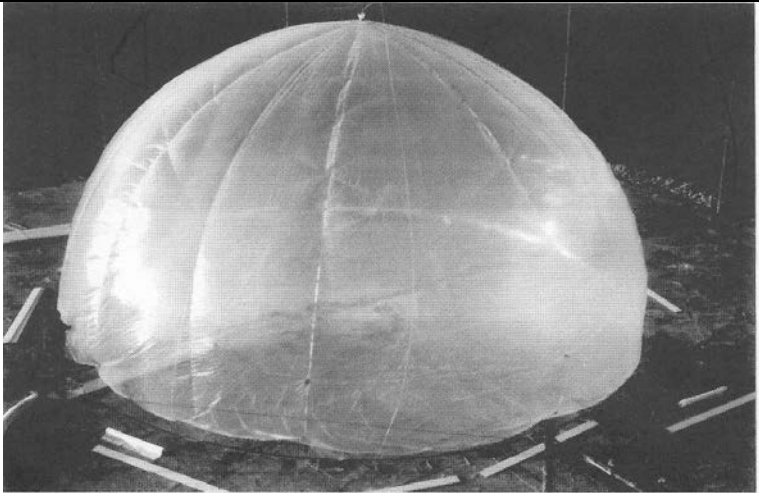
Experiment Name	Open Deflagration
Experiment Type	Deflagration
Keywords	Deflagration, Large-scale, Open environment
Draft drawing or simple description for the facility	
Short description	Deflagration of large-scale (initial radius 10 m) hemispherical stoichiometric hydrogen-air mixture in open atmosphere ignited at the centre of hemisphere.

Experiment Name	Vented_Def_BI_27V
Experiment Type	Deflagration
Keywords	Deflagration, Venting

<p>Draft drawing or simple description for the facility</p>	
<p>Short description</p>	<p>The experiment facility has the size of 4.6X3X4.6 m. In experiment, 18.2% H₂-Air mixture was filled homogenously inside the facility. On one side wall of the facility, a square size ventilation with the area of 2.7 m² is given. In the experiment, ignition point is given at the back of the facility, and then 4 pressure sensors and couples of thermal couples are used to record the experiment data.</p>

<p>Experiment Name</p>	<p>Vented_Def_BI_54V</p>
<p>Experiment Type</p>	<p>Deflagration</p>
<p>Keywords</p>	<p>Deflagration, Venting</p>
<p>Draft drawing or simple description for the facility</p>	
<p>Short description</p>	<p>The experiment facility has the size of 4.6X3X4.6 m. In experiment, 18.2% H₂-Air mixture was filled homogenously inside the facility. On one side wall of the facility, a square size ventilation with the area of 5.4 m² is given. In the experiment, ignition point is given at the back of back wall, and then 4</p>

	pressure sensors and couples of thermal couples are used to record the experiment data.
--	---

Experiment Name	Vented_Def_CI_27V
Experiment Type	Deflagration
Keywords	Deflagration, Venting
Draft drawing or simple description for the facility	
Short description	The experiment facility has the size of 4.6X3X4.6 m. in experiment, 18.2% H2-Air mixture was filled homogenously inside the facility. On one side wall of the facility, a square size ventilation with the area of 2.7 m ² is given. In the experiment, ignition point is given at the center of the facility, and then 4 pressure sensors and couples of thermal couples are used to record the experiment data.

Experiment Name	Vented_Def_CI_54V
Experiment Type	Deflagration
Keywords	Deflagration, Venting

<p>Draft drawing or simple description for the facility</p>	
<p>Short description</p>	<p>The experiment facility has the size of 4.6X3X4.6 m. In experiment, 18.2% H₂-Air mixture was filled homogenously inside the facility. On one side wall of the facility, a square size ventilation with the area of 5.4 m² is given. In the experiment, ignition point is given at the center of back wall, and then 4 pressure sensors and couples of thermal couples are used to record the experiment data.</p>

<p>Experiment Name</p>	<p>Vented_Def_FI_27V</p>
<p>Experiment Type</p>	<p>Deflagration</p>
<p>Keywords</p>	<p>Deflagration, Venting</p>
<p>Draft drawing or simple description for the facility</p>	
<p>Short description</p>	<p>The experiment facility has the size of 4.6X3X4.6 m. In experiment, 18.2% H₂-Air mixture was filled homogenously inside the facility. On one side wall of the facility, a square size ventilation with the area of 2.7 m² is given. In the experiment, ignition point is given at the front of the facility, and then 4</p>

	pressure sensors and couples of thermal couples are used to record the experiment data.
--	---

Experiment Name	Vented_Def_CI_54V
Experiment Type	Deflagration
Keywords	Deflagration, Venting
Draft drawing or simple description for the facility	
Short description	The experiment facility has the size of 4.6X3X4.6 m. in experiment, 18.2% H ₂ -Air mixture was filled homogenously inside the facility. On one side wall of the facility, a square size ventilation with the area of 5.4 m ² is given. In the experiment, ignition point is given at the front of back wall, and then 4 pressure sensors and couples of thermal couples are used to record the experiment data.

Experiment Name	Blast Wave
Experiment Type	Blast wave and fireball generated by hydrogen fuel tank rupture during fire exposure
Keywords	Blast wave, Fireball, Hydrogen Tank Rupture, Fire

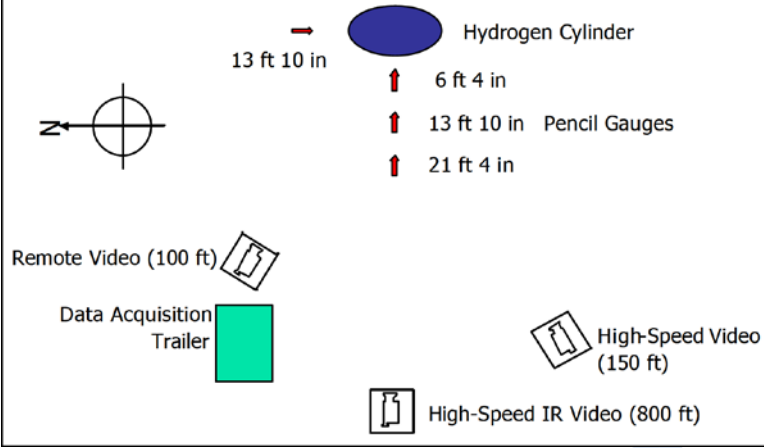
<p>Draft drawing or simple description for the facility</p>	 <p>Hydrogen Cylinder 13 ft 10 in 6 ft 4 in 13 ft 10 in Pencil Gauges 21 ft 4 in</p> <p>Remote Video (100 ft) Data Acquisition Trailer High-Speed Video (150 ft) High-Speed IR Video (800 ft)</p>
<p>Short description</p>	<p>Southwest Research Institute's® Department of Fire Technology, San Antonio, Texas, examined the effects of catastrophic failure of a 5.000-psig Type-IV hydrogen cylinder. Because it was the intent of the test to examine catastrophic failure, the test procedures were modified and the pressure relief device was removed so that controlled venting of the hydrogen from the cylinder during the test was prevented. The cylinder was filled at 34.5-MPa (1.64 kg) of hydrogen, 84 cm long, 41 cm diameter, with an inner volume of 72.4 L.</p> <p>The cylinder was placed over a propane bonfire source of 370 kW exposure. The cylinder was exposed to the fire for 6 min 27 sec when it lost its integrity and failed catastrophically.</p>

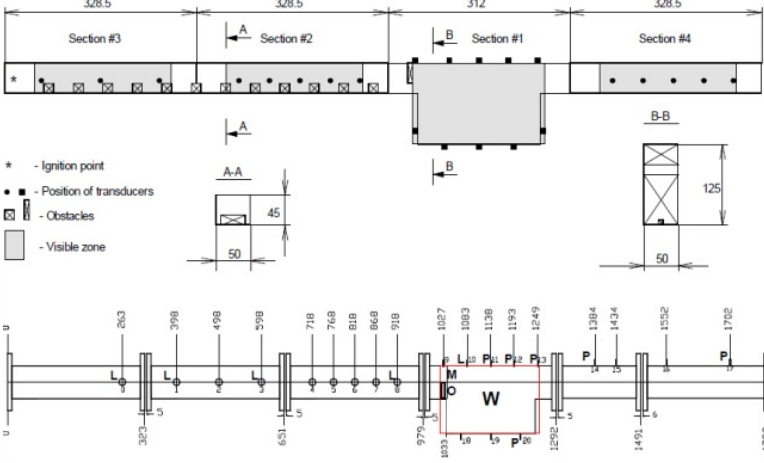
<p>Experiment Name</p>	<p>MINIRUT_m40</p>
<p>Experiment Type</p>	<p>Deflagration</p>
<p>Keywords</p>	<p>Deflagration, Flame Acceleration, Obstructed Environment, Complex Geometry</p>
<p>Draft drawing or simple description for the facility</p>	 <p>Section #3 328.5 Section #2 328.5 Section #1 312 Section #4 328.5</p> <p>* - Ignition point ● - Position of transducers □ - Obstacles ▭ - Visible zone</p> <p>A-A 45 50 B-B 125 50</p> <p>323 398 498 598 718 768 818 868 918 978 1027 1033 1093 1138 1193 1249 1292 1384 1434 1491 1552 1702 1792</p>

Short description	Investigation of flame acceleration was given in the scale-down MINIRUT facility. In the experiments, experiment facility was filled with 29% hydrogen-air mixtures, the mixture was ignited by a small sparking.
-------------------	---

DDT:

Experiment Name	FZK-R 049809
Experiment Type	DDT
Keywords	DDT, Flame Acceleration, Obstacles, Closed Tube
Draft drawing or simple description for the facility	
Short description	Combustion experiments have been carried out in obstructed tube of 350 mm in diameter and 12 m in length. Repeatable obstacles with blockage ratio BR=0.3 at distances 500mm. Hydrogen/air mixture with concentration of 15% H ₂ was tested.

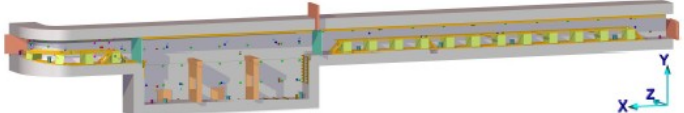
Experiment Name	DDT_RUT
Experiment Type	DDT
Keywords	DDT, Flame Acceleration, Obstacles, Complex Geometry
Draft drawing or simple description for the facility	
Short description	Investigation of flame acceleration and DDT were given in the RUT facility. In the experiments, hydrogen-air-steam mixtures with different concentrations are given to test of the criteria of DDT.

Experiment Name	MINIRUT_m44
Experiment Type	DDT

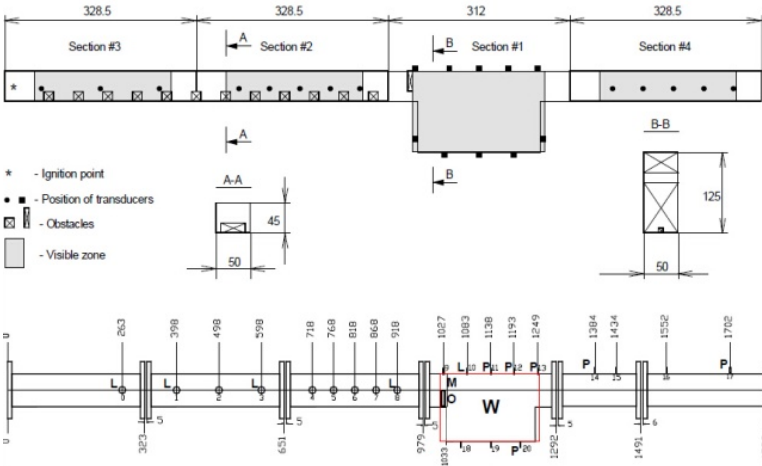
<p>Keywords</p>	<p>DDT, Flame Acceleration, Obstructed Environment, Complex Geometry</p>
<p>Draft drawing or simple description for the facility</p>	 <p>Based on the basic geometry shown by the drawing, a 60cm long smooth channel was installed in the left side of the obstructed channel to boost the flame acceleration.</p>
<p>Short description</p>	<p>Investigation of flame acceleration and DDT were given in the scale-down MINIRUT facility. In the experiments, the experiment facility was fill with homogenous 29% hydrogen air mixture and the mixture was ignited by small sparking.</p>

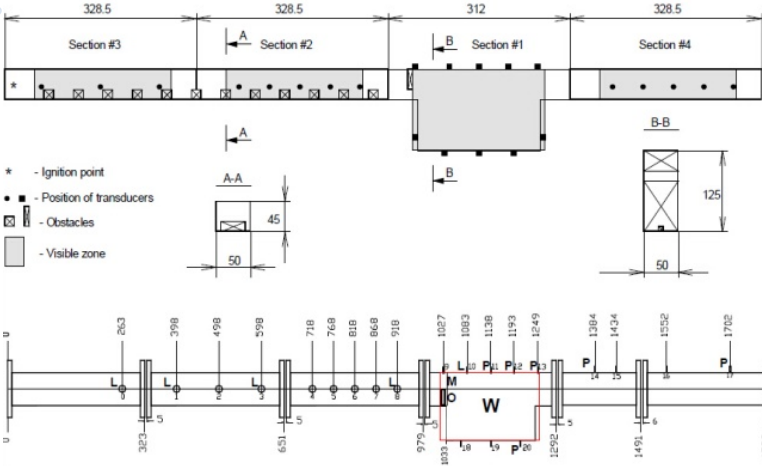
<p>Experiment Name</p>	<p>MINIRUT_m46</p>
<p>Experiment Type</p>	<p>DDT</p>
<p>Keywords</p>	<p>DDT, Flame Acceleration, Obstructed Environment, Complex Geometry</p>
<p>Draft drawing or simple description for the facility</p>	 <p>Based on the basic geometry shown by the drawing, a 20cm long obstructed channel (the same setting of obstacles) was</p>

	installed in the left side of the obstructed channel to boost the flame acceleration.
Short description	Investigation of flame acceleration and DDT were given in the scale-down MINIRUT facility. In the experiments, the experiment facility was fill with homogenous 29% hydrogen air mixture and the mixture was ignited by small sparking.

Experiment Name	GRS 029
Experiment Type	DDT
Keywords	Semi Confined Volume, Obstacle, Homogeneous mixture, Flame Acceleration
Draft drawing or simple description for the facility	
Short description	DDT experiment was done in the semi confined volume with size of 9mX3MX0.3M, inside the facility repeating 53% block ratio obstacles are installed for the flame acceleration. The experiment facility was filled with 23% hydrogen-air mixture, and the burnable gas was ignited by a 2m flame tube.

Experiment Name	GRS 037
Experiment Type	DDT
Keywords	Semi Confined Volume, Obstacle, Homogeneous Mixture, Flame Acceleration

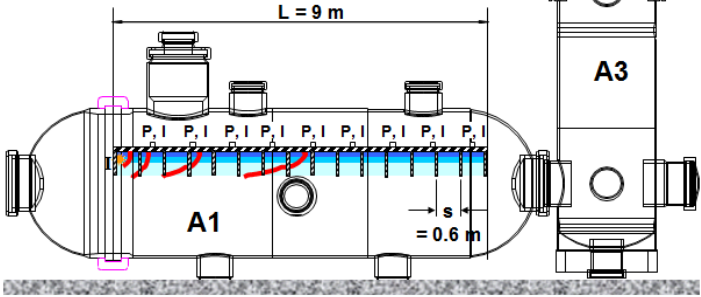
<p>Draft drawing or simple description for the facility</p>	
<p>Short description</p>	<p>DDT experiment was done in the semi confined volume with size of 9mX3MX0.6M, inside the facility repeating 50% block ratio obstacles are installed for the flame acceleration. The experiment facility was filled with 22% hydrogen-air mixture, and the burnable gas was ignited by a 2m flame tube.</p>

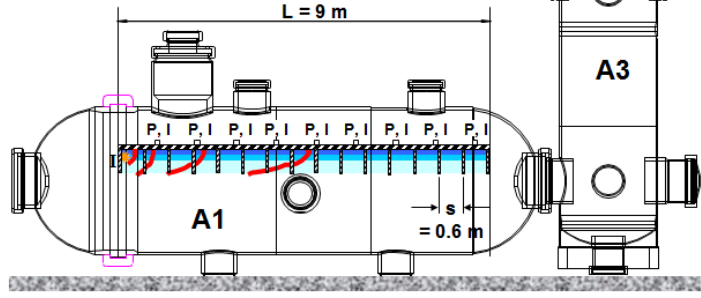
<p>Experiment Name</p>	<p>GRS 056</p>
<p>Experiment Type</p>	<p>DDT</p>
<p>Keywords</p>	<p>Semi Confined Volume, Obstacle, Gradient mixture, Flame Acceleration</p>
<p>Draft drawing or simple description for the facility</p>	
<p>Short description</p>	<p>DDT experiment was done in the semi confined volume with size of 9mX3MX0.6M, inside the facility repeating 50% block ratio obstacles are installed for the flame acceleration. The experiment facility was filled with gradient hydrogen-air mixture (on the top the concentration of hydrogen is 21.8% and the concentration decreases by 0.3% per cm), and the burnable gas was ignited by a 2m flame tube.</p>

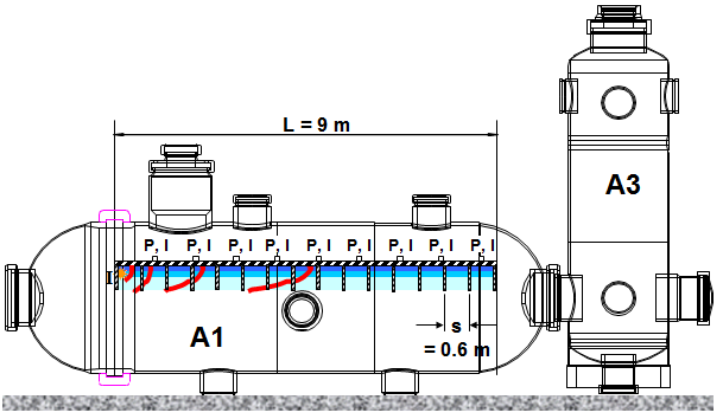
Experiment Name	GRS 057
Experiment Type	DDT
Keywords	Semi Confined Volume, Obstacle, Gradient Mixture, Flame Acceleration
Draft drawing or simple description for the facility	
Short description	DDT experiment was done in the semi confined volume with size of 9mX3MX0.6M, inside the facility repeating 50% block ratio obstacles are installed for the flame acceleration. The experiment facility was filled with gradient hydrogen-air mixture (on the top the concentration of hydrogen is 15.6% and the concentration decreases by 0.2% per cm), and the burnable gas was ignited by a 2m flame tube.

Detonation:

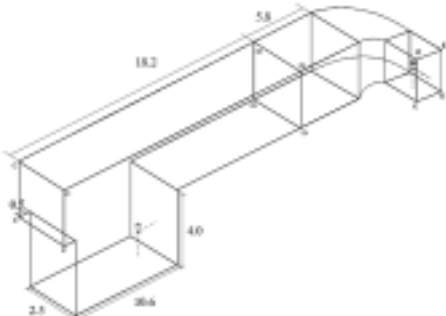
Experiment Name	KI-RUT-Hyd05
Experiment Type	Detonation
Keywords	Detonation, Large-scale, Complex Geometry
Draft drawing or simple description for the facility	

Short description	Detonation experiments have been carried out in large scale confined complex geometry (263 m ³). Uniform hydrogen/air mixture with concentration of 20.0% H ₂ was tested.
-------------------	--

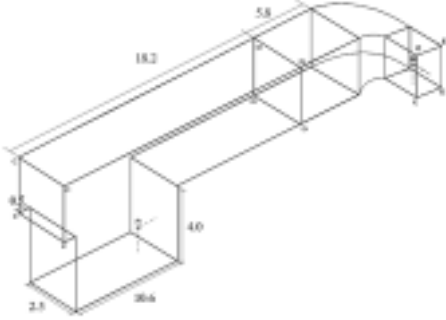
Experiment Name	KI-RUT-Hyd09
Experiment Type	Detonation
Keywords	Detonation, Large-scale, Complex Geometry
Draft drawing or simple description for the facility	
Short description	Detonation experiments have been carried out in large scale confined complex geometry (263 m ³). Uniform hydrogen/air mixture with concentration of 25.5% H ₂ was tested. Ignition in the channel (B).

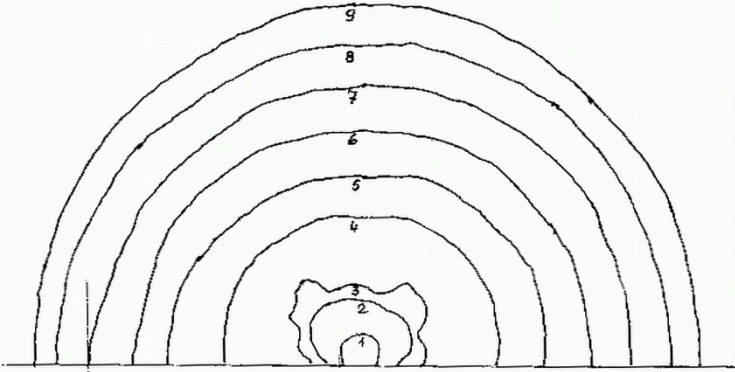
Experiment Name	Open Detonation
Experiment Type	Detonation
Keywords	Detonation, Large-Scale, Open Environment
Draft drawing or simple description for the facility	
Short description	Detonation of 29.05% (by vol.) hydrogen-air quiescent mixture in the 53 m ³ hemispherical balloon (diameter 2.93 m). Central

	point ignition source.
--	------------------------

all rights reserved